

Table of Contents

1. Safety precautions	1
1.1. General warnings	1
1.2. Charge and discharge warnings	1
1.3. Transportation warnings	2
1.4. Disposal of lithium batteries	2
2. Introduction	3
2.1. Description	3
2.2. Features	3
3. System design and BMS selection guide	4
3.1. Maximum number of batteries in series, parallel or series/parallel configuration	4
3.2. The BMS alarm signals and BMS actions	4
3.2.1. The BMS's pre-alarm signal	5
3.3. The BMS models	6
3.3.1. The Lynx Smart BMS NG	7
3.4. Charging from an alternator	8
3.5. Battery monitoring	8
4. Installation	9
4.1. Unpacking and handling the battery	9
4.2. Download and install the VictronConnect app	9
4.2.1. Update the battery and BMS firmware	9
4.3. Initial charging before use	10
4.3.1. Why charge batteries before use	10
4.3.2. How to charge batteries before use	10
4.4. Mounting	12
4.5. Connecting battery cables	12
4.5.1. Cable cross-sectional area and fuse ratings	12
4.5.2. Connecting a single battery	12
4.5.3. Connecting multiple batteries in series	13
4.5.4. Connecting multiple batteries in parallel	13
4.5.5. Connecting multiple batteries in series/parallel	13
4.5.6. Battery banks consisting of different batteries	14
4.6. Connecting the BMS	14
4.7. Charger settings	15
4.8. Commissioning	15
5. Operation	16
5.1. Monitoring & Control	16
5.1.1. Monitoring the battery via VictronConnect	16
5.1.2. Monitoring the battery via a GX device	17
5.1.3. Monitoring the battery via the VRM Portal	17
5.2. Battery charging and discharging	17
5.2.1. Charging the battery and recommended charger settings	17
5.2.2. Discharging	19
5.3. Observe the operating conditions	19
5.4. Battery care	21
6. Troubleshooting & support	22
6.1. Battery issues	22
6.1.1. How to recognise cell imbalance	22
6.1.2. Causes for cell imbalance or a variation in cell voltages	22
6.1.3. How to recover an imbalanced battery	23
6.1.4. Less capacity than expected	23
6.1.5. Battery very low terminal voltage	24
6.1.6. Battery is close to end-of-cycle life or has been misused	25
6.2. BMS issues	26
6.2.1. The BMS frequently disables the battery charger	26
6.2.2. The BMS is prematurely turning chargers off	26
6.2.3. The BMS is prematurely turning loads off	26
6.2.4. The BMS is displaying an alarm while all cell voltages are within range	26

6.2.5. How to test if the BMS is functional	27
7. Warnings, alarms and errors	28
7.1. E-SL1: Balancer failure	28
7.2. W-SL11: Under voltage warning (pre-alarm)	28
7.3. A-SL9 Over voltage alarm	28
7.4. A-SL11: Under voltage alarm	28
7.5. A-SL15: Over temperature alarm	28
7.6. A-SL22: Under temperature alarm	28
7.7. E-SL2: Internal communication failure	28
7.8. E-SL9: Overlapped voltage error	28
7.9. E-SL10: Balancer update error	29
7.10. E-SL24: Hardware failure	29
7.11. E-SL119: Settings data lost	29
8. Technical data	30
8.1. Battery specification	30
8.2. Enclosure dimensions	31

1. Safety precautions



- Observe these instructions and keep them located near the battery for future reference.
- The Material Safety Datasheet can be downloaded from the “Material Safety Datasheet menu” located on the [Lithium Smart product page](#).
- Work on a lithium battery should be carried out by qualified personnel only.

1.1. General warnings

- While working on a lithium battery, wear protective eyeglasses and clothing.
- Any leaked battery material, such as electrolyte or powder on the skin or the eyes, must immediately be flushed with plenty of clean water. Then seek medical assistance. Spillages on clothing should be rinsed out with water.
- Explosion and fire hazard. You must use a type D foam or CO₂ fire extinguisher in case of fire.
- The terminals of a lithium battery are always live; therefore, metallic items or tools should not be placed on top of the battery.
- Use insulated tools.
- Do not wear any metallic items such as watches, bracelets, etc.
- Avoid short circuits, very deep discharges and excessive charge or discharge currents.



- Do not open or dismantle the battery. Electrolyte is very corrosive. In normal working conditions, contact with the electrolyte is impossible. If the battery casing is damaged, do not touch the exposed electrolyte or powder because it is corrosive.
- Lithium batteries are heavy. To avoid muscle strain or back injury, use lifting aids and proper lifting techniques when installing or removing batteries.
- If involved in a vehicle accident, they can become a projectile! Ensure adequate and secure mounting and always use suitable handling equipment for transportation.
- Handle with care because a lithium battery is sensitive to mechanical shock.
- Do not use a damaged battery.
- Water will damage your battery. Discontinue use and seek further advice.

1.2. Charge and discharge warnings



- Use only with a Victron Energy-approved type NG BMS.
- Overcharging or deep discharging will seriously damage a lithium battery and may render it unsafe for continued use. Therefore, an external safety relay is mandatory.
- If charged after the lithium battery was discharged below the “Discharge cut-off voltage” or when damaged or overcharged, the battery can release a harmful mixture of gases, such as phosphate.
- The battery can be charged between 5 °C and 50 °C. Charging it at temperatures outside this range may cause severe damage to the battery or reduce its life expectancy.
- The battery's discharge temperature range is -20 °C to 50 °C. Discharging the battery at temperatures outside this range may cause severe damage to the battery or reduce its life expectancy.

1.3. Transportation warnings



- The battery must be transported in its original or equivalent package and in an upright position. If the battery is in its cardboard packaging, use soft slings to avoid damage. Ensure that all packaging materials are non-conductive.
- Cartons or crates used to transport lithium batteries must have an approved warning label affixed.
- Air transportation of lithium batteries is prohibited.
- Do not stand below a battery when it is hoisted.
- Never lift the battery at the terminals or the BMS communication cables; only lift the battery at the handles.



- Batteries are tested according to the UN Handbook of Tests and Criteria, part III, sub-section 38.3 (ST/SG/AC.10/11/Rev.5).
- For transport, the batteries belong to the category UN3480, Class 9, Packaging Group II and have to be transported according to this regulation. This means that for land and sea transport (ADR, RID & IMDG) they have to be packed according to packaging instruction P903 and for air transport (IATA) according to packaging instruction P965. The original packaging complies with these instructions.

1.4. Disposal of lithium batteries



- Do not throw a battery into fire.
- Batteries must not be mixed with domestic or industrial waste.
- Batteries marked with the recycling symbol  must be processed via a recognised recycling agency. By agreement, they may be returned to the manufacturer.

2. Introduction

2.1. Description

Victron Energy Lithium NG batteries are Lithium Iron Phosphate (LiFePO₄ or LFP) batteries available in various capacities with nominal voltages of 12.8V, 25.6V, and 51.2V. They can be connected in series, parallel, or series/parallel so that a battery bank can be built for system voltages of 12V, 24V, or 48V. The maximum number of batteries in one system is 50, which results in a maximum energy storage of 192kWh in a 12V system and up to 384kWh in a 24V and 48V system.

This is the safest of the mainstream lithium battery types and is the battery chemistry of choice for very demanding applications.

2.2. Features

Integrated cell balancing, temperature and voltage control system

- The battery has an integrated balancing, temperature and voltage control system (BTV) that must be connected to an external battery management system (BMS). The BTV monitors each individual battery cell, balances the cell voltages and generates an alarm signal in case of high or low cell voltage or in case of high or low cell temperature. The BMS (must be purchased separately; see the [The BMS models \[6\]](#) chapter for an overview of available BMS models and functionality) receives this alarm signal, which then switches off the loads and/or chargers accordingly.

Integrated shunt

- The battery data (battery voltage, current and temperature) are transmitted to the BMS and evaluated there, i.e. to calculate the state of charge, which can then be read out via VictronConnect or a [GX communication centre](#), or to create and issue specific warnings and alarms.

Automatic setup, monitoring and control via VictronConnect or a GX device and the VRM Portal

- The BMS automatically manages all battery parameters. It detects the system voltage and the number of batteries in parallel, series, and series/parallel connections. The BMS (from now on Lynx Smart BMS NG 500 A/1000 A, further models to follow) is mandatory and must be purchased separately.
- Monitoring and control take place via VictronConnect (every BMS model has Bluetooth), a GX communication centre or the VRM Portal. You can view battery parameters such as cell status, voltages, battery current and temperature in real-time. The BMS also automatically updates the battery firmware. Please see the [Monitoring & Control \[16\]](#) chapter for details.
- To learn more about the VictronConnect app and its functions, please refer to the VictronConnect manual, which can be downloaded from the [product page](#).

Easy bracket mounting

- Mounting brackets make the installation easier and ensure that the battery is optimally secured against slipping and tipping over. Optionally, the batteries can also be secured with straps.

Increased ingress protection (IP-rating)

- The Lithium NG batteries are effectively sealed against dust and can withstand low-pressure water jets, making them suitable for environments where exposure to dust and water is a concern.

Low self-discharge rate

- The self-discharge rate has been significantly improved and is now a maximum of 3 % of the battery capacity per month. A low self-discharge rate contributes to the overall performance, longevity, and reliability of the NG batteries.

Other features

- High round-trip efficiency
- High energy density - More capacity with less weight and volume
- High charge and discharge currents, enabling fast charging and discharging

3. System design and BMS selection guide

This chapter describes how the battery interacts with the BMS and how the BMS interacts with loads and chargers to protect the battery. This information is important for system design and the selection of the most suitable BMS for the system.

3.1. Maximum number of batteries in series, parallel or series/parallel configuration

A system can use up to 50 Victron Lithium NG batteries in total, regardless of the Victron BMS NG used. This enables 12V, 24V, and 48V energy storage systems with up to 384kWh (192kWh for a 12V system), depending on the capacity used and the number of batteries. See the [Installation \[9\]](#) chapter for installation details.

Check the table below to see how the maximum storage capacity can be achieved (using 12.8V/300Ah, 25.6V/300Ah and 51.2V/100Ah batteries as an example):

System voltage	12.8V/300Ah	Nominal energy	25.6V/300Ah	Nominal energy	51.2V/100Ah	Nominal energy
12V	50 in parallel	192kWh	na	na	na	na
24V	50 in 2S25P	192kWh	50 in parallel	384kWh	na	na
48V	48 in 4S12P	184kWh	50 in 2S25P	384kWh	50 in parallel	256kWh

3.2. The BMS alarm signals and BMS actions

The battery itself monitors cell voltages, current and battery temperature. The BMS constantly processes this data and, in addition to displaying it via the VictronConnect app and/or a GX device, creates warnings and alarms as needed, for example, when a low cell voltage is imminent or the battery temperature becomes too low to allow the battery to charge.

To protect the battery, the BMS then switches off consumers and/or chargers or generates a pre-alarm in order to have enough time to take countermeasures.

These are the possible battery warnings and alarms and the corresponding BMS actions:

BMS alarm signal	BMS action
Low cell voltage pre-alarm warning (≤ 3.0 V)	The BMS generates a pre-alarm signal
Low cell voltage alarm with a minimum delay of 30 seconds (≤ 2.8 V)	The BMS turns loads off
High cell voltage alarm (≥ 3.6 V)	The BMS turns chargers off
Low battery temperature alarm (< 5 °C)	The BMS turns chargers off
High battery temperature alarm (> 50 °C)	The BMS turns chargers off

The battery communicates its data to the BMS via the BMS cables.

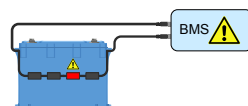

The BMS receives a low cell voltage from a battery cell

If the system contains multiple batteries, all battery BMS cables are connected in series (daisy chained). The first and the last BMS cable is connected to the BMS.

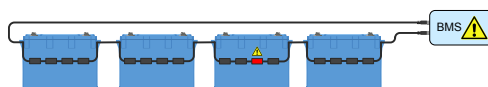

The BMS receives a high cell voltage from a cell in a multiple-battery setup

The battery is equipped with 50 cm long BMS cables. If these cables are too short to reach the BMS, they can be extended with [BMS extension cables](#).

There are two ways the BMS can control loads and chargers:

1. By sending an electrical or digital on/off signal to the charger or load.
2. By physically connecting or disconnecting a load or a charge source from the battery. Either directly or by using a [BatteryProtect](#) or [Cyrix Li-ion relay](#).

All available BMS types for the NG battery are based on either or both of these technologies. The BMS types and their functionality are briefly described in the next chapters.

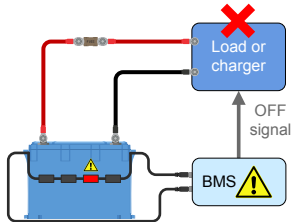

The BMS sends an on/off signal to a load or charger

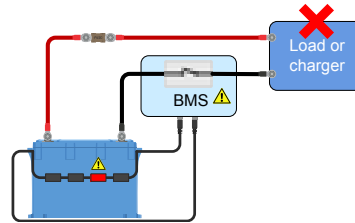

The BMS connects or disconnects from a load or charger

3.2.1. The BMS's pre-alarm signal

The purpose of the pre-alarm is to warn that the BMS is about to turn off the loads because one or more cells have reached the cell undervoltage pre-alarm threshold (3.0 V, hardcoded). We recommend connecting the BMS's pre-alarm output to a visible or audible alarm device. When the pre-alarm is raised, the user can turn on a charger to prevent the DC system from shutting down.

Switching behaviour

In case of an imminent under-voltage shutdown, the BMS's pre-alarm output will switch on. If the voltage continues to decrease, the loads are switched off (load disconnect), and at the same time, the pre-alarm output will switch off again. If the voltage rises again (the operator has enabled a charger or has reduced the load), the pre-alarm output will switch off once the lowest cell voltage has been increased above 3.2 V.

The BMS ensures a minimum delay of 30 seconds between enabling the pre-alarm and the load disconnect. This delay allows the operator a minimal amount of time to prevent the shutdown.

3.3. The BMS models

Currently, only the Lynx Smart BMS NG is available, with additional models expected to follow soon.

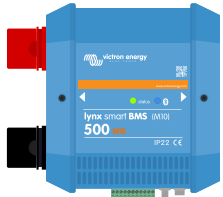
BMS type	Voltage	Features	Typical application
 <p>Lynx Smart BMS 500A NG and Lynx Smart BMS 1000A NG</p>	12, 24 or 48 V	<ul style="list-style-type: none"> Controls loads and chargers via on/off signals Can control inverter/chargers, solar chargers and select DC and AC chargers via DVCC Generates a pre-alarm signal 500A or 1000A contactor to disconnect the system positive Battery monitor Bluetooth Can connect to a GX device via VE.Can Can be combined with all Lynx M10 busbar products Remote On/Off/Standby via VictronConnect app or a GX device Installed in the system positive and negative Instant Readout via Bluetooth 	<ul style="list-style-type: none"> Larger systems with digital integration or when a built-in safety relay is needed Also systems with inverter/chargers if GX device is present

3.3.1. The Lynx Smart BMS NG

The Lynx Smart BMS NG is used in medium to large systems that contain DC loads and AC loads via inverters or inverter/chargers, for example, on yachts or recreational vehicles. This BMS is equipped with a contactor that disconnects the DC system, a "Load disconnect," a "Charge disconnect," a "pre-alarm" contact, and a battery monitor. In addition, it can be connected to a GX device and control compatible Victron Energy equipment via DVCC.

- In the event of low cell voltage, the BMS will send a "Load disconnect" signal to turn the load(s) off.
- Before turning a load off, it will send a pre-alarm signal indicating imminent low cell voltage.
- In case of high cell voltage or low/high battery temperature, the BMS will send a "Charge disconnect" signal to turn the charger(s) off.
- If the batteries are even further discharged (or overcharged), the contactor will open, effectively disconnecting the DC system to protect the batteries.

For more information, see the Lynx Smart BMS NG manual, which can be found on the [Lynx Smart BMS product page](#).

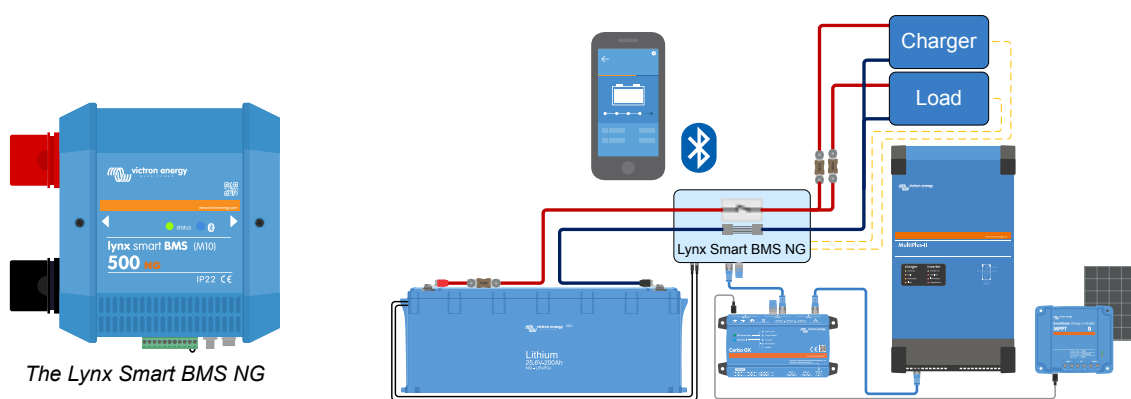

The Lynx Smart BMS NG

The Lynx Smart BMS NG will turn loads and chargers off via "load disconnect", and "charge disconnect" signals and controls the inverter/charger via a GX device. Should the battery be discharged even further, the BMS will disconnect the battery from the DC system.

3.4. Charging from an alternator

Compared to lead-acid batteries, lithium batteries have a very low internal resistance and accept a much higher charging current. Special care must be taken to avoid overloading the alternator:

1. Ensure the alternator's current rating is at least twice the battery's capacity rating. For example, a 400A alternator can be safely connected to a 200Ah battery.
2. Use an alternator equipped with a temperature-controlled alternator regulator. This prevents the alternator from overheating.
3. Use a current-limiting device like a [DC-DC charger](#) or a [DC-DC converter](#) between the alternator and the starter battery.

For more information on charging lithium batteries with an alternator, see the [Alternator lithium charging blog and video](#).

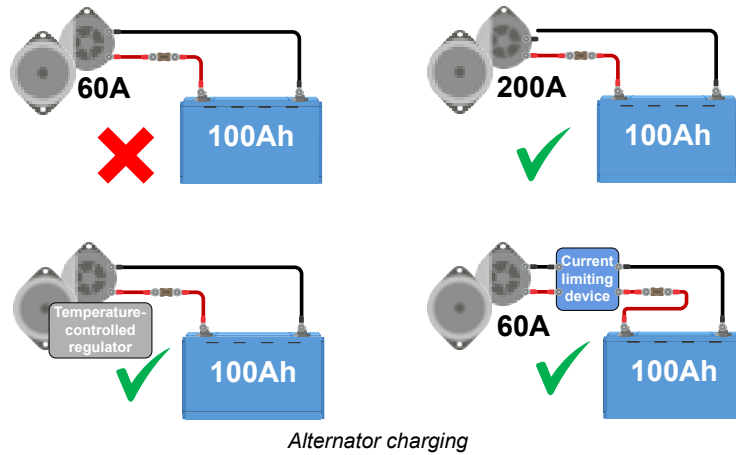

3.5. Battery monitoring

Common battery parameters such as battery voltage, battery temperature, battery current and cell voltages can be read out via Bluetooth using the VictronConnect app via the BMS. If a GX device (with internet) is used in conjunction with a Lynx Smart BMS NG, the data will also be made available on the VRM portal.

If, for some reason, you use an additional battery monitor in the system, ensure that the following settings are made so that the calculation of the SoC and the charged and discharged energy is done correctly:

- Set the charge efficiency to 99%
- Set the Peukert exponent to 1.05

Also, ensure that the external battery monitor is powered from the load terminal of the BMS and not directly from the battery to prevent accidental battery discharge.

For more information on battery monitors, see the [Battery monitor product page](#).

4. Installation

4.1. Unpacking and handling the battery

Take care when unpacking the battery. Batteries are heavy. Do not lift the battery by its terminals or by its BMS cables. The battery has two carry handles on either side. The weight of the battery can be found in the [Technical data \[30\]](#) chapter.

Familiarise yourself with the battery. The main battery terminals on the top have a “+” symbol for positive and a “-” symbol for negative to ensure correct polarity.

Each battery has two BMS cables for communicating with the BMS. One cable has a male 3-pole connector, and the other has a female 3-pole connector. Depending on the battery model, the BMS cables are located on one side of the battery or two opposite sides of the battery.

Ensure that the BMS cables do not get snagged or damaged when handling the battery.

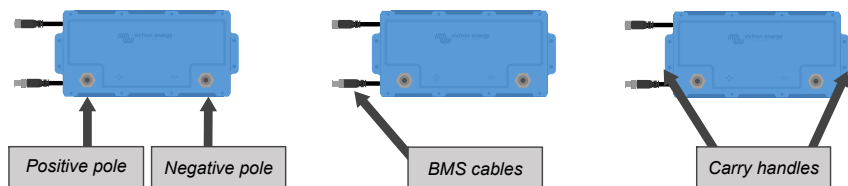

Top view and side views showing battery terminals (+ and -), BMS cables, and carry handles

4.2. Download and install the VictronConnect app

Download the VictronConnect app for Android, iOS or macOS from their respective app stores. For more information about the app, see the [VictronConnect product page](#).

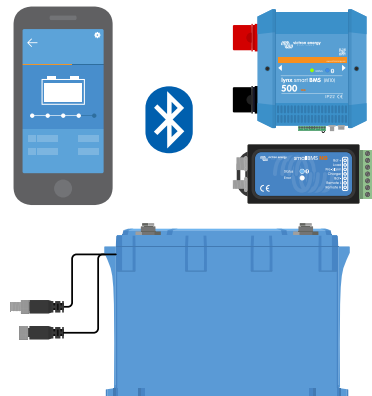

The VictronConnect app communicates with the BMS via Bluetooth

4.2.1. Update the battery and BMS firmware

When the BMS firmware is updated, the battery firmware is also automatically updated. This happens either via the VictronConnect app or, in the case of a Lynx Smart BMS NG in conjunction with a GX device, via the VRM portal. Also, make sure you have the latest VictronConnect version. This ensures that the latest battery and BMS firmware version is available.

The VictronConnect app might ask to update the firmware on the first connection. If this is the case, let it perform a firmware update.

If one or more batteries are added to the system at a later date, the battery firmware will be automatically updated by the BMS.

To check the battery and BMS firmware version, do the following:

1. Connect to the BMS using the VictronConnect app.
2. Click on the cog wheel icon at the top right to go to the Settings page.
3. On the Settings page, click on the Option symbol  to go to the Product info page.
4. Check to see if you are running the latest firmware. Look for the text "This is the latest version."
5. To view the battery's current firmware version, return to the Settings page and click the Battery tab. If more than one battery is installed, select the battery by clicking on the battery number (red circle).
6. If the BMS does not have the most up-to-date firmware, perform a firmware update. Please refer to the BMS manual for details.

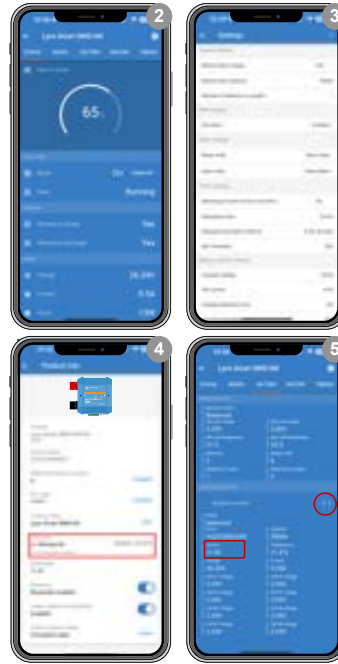

4.3. Initial charging before use

4.3.1. Why charge batteries before use

This section only applies if you intend to connect batteries in series.

Lithium batteries are only approximately 50 % charged when shipped from the factory. This is a transportation safety requirement. However, due to differences in transportation routes and warehousing, the batteries do not always have the same state of charge by the time they are installed.

Individually charging new batteries before connecting them in series will shorten the charging time.

The built-in battery cell balancing system can only correct small differences in state of charge from one battery to another. New batteries can have large state of charge differences between them that won't be corrected if installed that way, especially when connected in series. Please note that differences in state of charge between batteries is not the same thing as imbalances between cell voltages within a battery. This is because the cell balancing circuits in one battery cannot affect the cells in another battery.

4.3.2. How to charge batteries before use



Always use a BMS-controlled charger when individually charging lithium batteries.

Initial charge procedure:

1. If a battery bank consists of batteries connected in series to make a higher voltage bank, each battery must first be charged individually. Use a dedicated charger or an inverter/charger with a BMS to perform the initial charge.
Only a single battery or a bank of parallel connected batteries can be charged as one.
Refer to the BMS manual for instructions on how to set it up.
2. Set the charger to the charge profile as indicated in the [Charging the battery and recommended charger settings \[17\]](#) section.
3. Ensure that the battery, the BMS and the charger are communicating with each other. Check this by disconnecting one of the battery BMS cables from the BMS and verifying that the charger turns off. Then reconnect the BMS cable and verify that the charger turns back on.
4. Turn the charger on and check that the charger is charging the battery.
Note that if, during charging, there is any imbalance between the battery cells, then the BMS may turn the charger off and on repeatedly. You may notice that the charger is turned off for a few minutes and then on again for a short period of time before being turned off again. Don't be alarmed; this pattern will repeat itself until the cells are balanced. If the cells are balanced, then the charger will not turn off until the battery is fully charged.

- The battery is fully charged when the battery charger has reached the float stage and the VictronConnect app battery cell status is "balanced." If the battery cell status is "unknown" or "imbalanced," the battery charger will be restarted multiple times until it is "balanced".

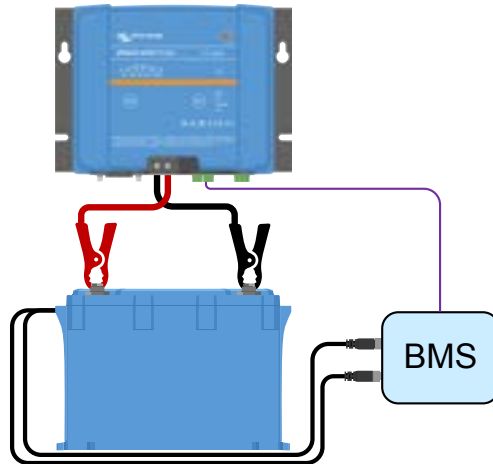

Initial charge using a BMS

4.4. Mounting

Mounting must meet the following requirements:

1. The battery can be mounted upright or on its side, but not with the battery terminals facing down.
2. The battery is only suitable for indoor use and needs to be installed in a dry location.
3. Batteries are heavy. When moving the battery into its destined location, use suitable handling equipment for transportation.
4. Ensure adequate and secure mounting, as the battery can become a projectile if involved in a vehicle accident.
5. Batteries produce a certain amount of heat when they are charged or discharged. Keep a 20 mm space on all four sides of the battery for ventilation.

4.5. Connecting battery cables

Observe the battery polarity when connecting the battery terminals to a DC system or other batteries. Take care not to short-circuit the battery terminals.

Connect the cables as indicated in the diagram:

1. Bolt
2. Spring washer
3. Washer
4. Cable lug
5. Battery terminal

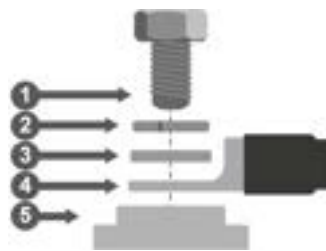

Battery cable connection

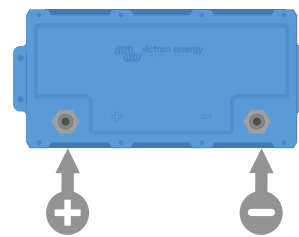

Battery terminals



Tighten the bolts with a torque of 10 Nm. Only use insulated tools that match the bolt head size.

4.5.1. Cable cross-sectional area and fuse ratings

Use battery cables with a cross-sectional area that matches the currents that can be expected in the battery system.

Batteries can produce very large currents; it is essential that all electrical connections to the battery are fused.

The battery cables must be sized to carry the maximum expected system current, and an appropriately rated fuse for the battery cable size must be used.

For more information on cable cross-sectional area, fuse types and fuse ratings, please see the [Wiring Unlimited book](#).

The battery maximum discharge rating is indicated in the [Technical data \[30\]](#) table. The system current and therefore the fuse rating should not exceed this current rating. The fuse has to match the lowest current rating, that being the cable current rating, the battery current rating or the system current rating.

4.5.2. Connecting a single battery

- Fuse the battery on the positive side.
- Connect the battery to the DC system.

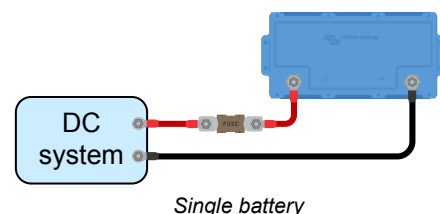

Single battery

4.5.3. Connecting multiple batteries in series

- Each individual battery needs to have been fully charged and balanced.
- Connect a maximum of four 12.8V batteries or a maximum of two 25.6V batteries in series.
- Connect the negative to the positive of the next battery.
- Fuse the series string on the positive side.
- Connect the battery bank to the system.

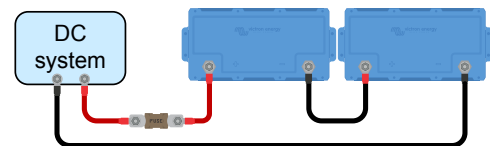

Multiple batteries in series

4.5.4. Connecting multiple batteries in parallel

- A total of 50 batteries can be connected in parallel.
- Fuse each battery on the positive side.
- Connect the DC system cables diagonally to ensure an equal current path through each battery.
- Take care that the cross-sectional area of the system cable is equal to the cross-sectional area of the string cable times the number of strings.
- Fuse the positive main cable going to the battery bank.
- Connect the battery bank to the DC system.
- See the [Wiring Unlimited](#) book for more information on constructing a parallel battery bank.

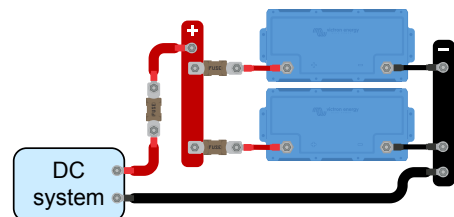

Multiple batteries in parallel

4.5.5. Connecting multiple batteries in series/parallel

- Connect a maximum of 50 batteries in a parallel/series combination.
- Each individual battery needs to have been fully charged and balanced.
- Fuse each series string on the positive side.
- Do not interconnect midpoints nor connect anything else at the midpoints.
- Connect the system cables diagonally to ensure an equal current path through each battery string.
- Take care that the cross-sectional area of the system cable is equal to the cross-sectional area of the string cable times the number of strings.
- Fuse the positive main cable going to the battery bank.
- Connect the battery bank to the DC system.

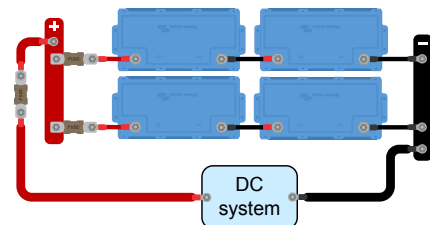

Multiple batteries in series/parallel



Do not interconnect midpoints nor connect anything else at the midpoints

4.5.6. Battery banks consisting of different batteries

When constructing a battery bank, ideally, all batteries should be of the same capacity, age and model. However, there are situations where this is impossible, such as when capacity needs to be expanded by adding more batteries or when a single battery in a battery bank needs to be replaced. In these cases, follow the guidelines in the table below.

Battery bank type	Different capacities allowed?	Different ages allowed?
Parallel	Yes	Yes
Series	No ¹⁾	Yes ²⁾
Series/parallel - within a series string	No ¹⁾	Yes ²⁾
Series/parallel - in case a whole series string is replaced or added	Yes	Yes

¹⁾ All batteries must have the same capacity rating and the same part number
²⁾ The age difference should not exceed 3 years

Background information:

Due to old batteries having reduced capacity, connecting them in series with new batteries or connecting different capacity batteries in series will result in an imbalance between the batteries. This imbalance will increase over time and cause an overall reduction in battery bank capacity. Theoretically, the battery with the lowest capacity would determine the overall capacity of a series string, but in reality, the overall series string capacity will reduce further over time. For example, if a 50Ah battery is connected in series with a 100Ah battery, the overall string capacity is 50Ah. But over time, the batteries become imbalanced, and when the imbalance has become, let's say, 10Ah, the overall battery capacity will be 50Ah-10Ah = 40Ah. The cells of the fullest battery will have an overvoltage during charging, while they are not able to send the excess voltage to the other battery cells. The BMS will constantly interfere, resulting in the emptiest battery is being discharged too deeply and the fullest battery is being overcharged.

4.6. Connecting the BMS

Each battery has two BMS cables with an M8 male and M8 female connector that need to be connected to the BMS.

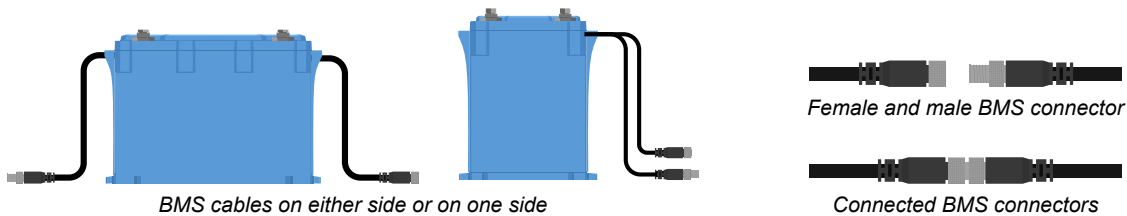

How to connect the cables:

- For a single battery, connect both cables directly to the BMS.
- For a battery bank consisting of multiple batteries, interconnect each battery (daisy chain) and connect the first and last cable to the BMS. The batteries can be interconnected in any order.
- If the BMS is too far away for the cables to reach, use the optional extension cables. The extension cables are available as a pair and come in various lengths. For more information, see the [extension cable product page](#).

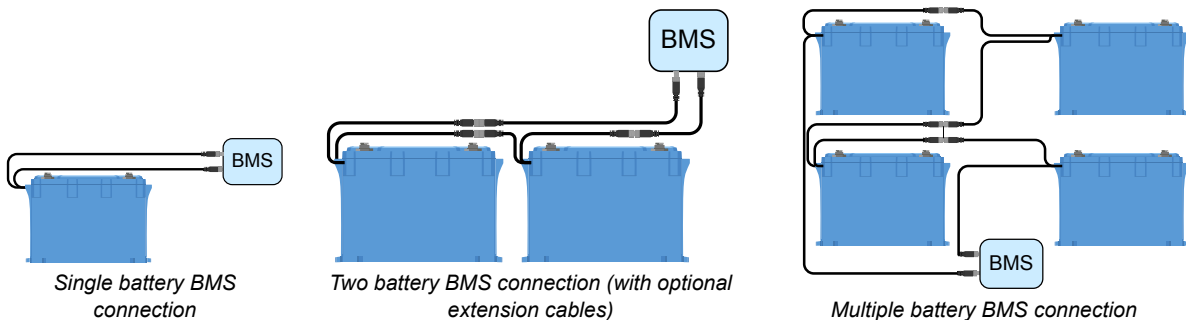

4.7. Charger settings

The recommended charging parameters for the charging sources are:

- **For 12.8V models:** 14.2V absorption voltage, 2 hours absorption time and 13.5V float voltage
- **For 25.6V models:** 28.4V absorption voltage, 2 hours absorption time and 27.0V float voltage
- **For the 51.2V model:** 56.8V absorption voltage, 2 hours absorption time and 54.0V float voltage

For the recommended charge currents, please see the [Charging the battery and recommended charger settings \[17\]](#) chapter and refer to the table in the [Technical data \[30\]](#) chapter.

For more information on the charging settings of the individual chargers or inverters/chargers, please refer to the manuals on the respective product page.

Adjusting charging voltages is not required for DVCC-controlled inverters/chargers and chargers such as the Orion XS and MPPT solar chargers. This setting is automatic and slightly different from a manual setting. For more information about DVCC, see your GX device manual on the respective [product page](#).

4.8. Commissioning

Once all connections have been made, the system wiring needs to be checked, the system needs to be powered up, and the BMS functionality needs to be checked. Follow this checklist:

- | | |
|--------------------------|--|
| <input type="checkbox"/> | Check the polarity of all battery cables. |
| <input type="checkbox"/> | Check the cross-sectional area of all battery cables. |
| <input type="checkbox"/> | Check if all battery cable lugs have been crimped correctly. |
| <input type="checkbox"/> | Check if all battery cable connections are tight (don't exceed maximum torque). |
| <input type="checkbox"/> | Tug slightly on each battery cable and see if the connections are tight. |
| <input type="checkbox"/> | Check all BMS cable connections and make sure the connector screw rings are screwed all the way down. |
| <input type="checkbox"/> | Connect the system positive and negative DC cable to the battery (or battery bank). |
| <input type="checkbox"/> | Check the string fuse(s) rating (if applicable). |
| <input type="checkbox"/> | Install the string fuse(s) (if applicable). |
| <input type="checkbox"/> | Check the main fuse rating. |
| <input type="checkbox"/> | Install the main fuse. |
| <input type="checkbox"/> | Check if all battery charge sources have been set to the correct charge settings. |
| <input type="checkbox"/> | Turn on all battery chargers and all loads. |
| <input type="checkbox"/> | Check if the BMS is powered up. |
| <input type="checkbox"/> | Disconnect a random BMS cable and verify that the BMS is turning off all charge sources and all loads. |
| <input type="checkbox"/> | Reconnect the BMS cable and check if all charge sources and loads turn back on. |

5. Operation

5.1. Monitoring & Control

A BMS is always required to monitor and control the battery.

The battery parameters can be read out in different ways:

1. Via Bluetooth with the [VictronConnect app](#)
2. Via [VictronConnect Remote \(VC-R\)](#): This requires a GX device to be connected to a Lynx Smart BMS NG, and the data must be transmitted to the VRM portal.
3. Via the [VRM Portal](#): This requires a GX device to be connected to a Lynx Smart BMS NG, and the data must be transmitted to the VRM portal.

Depending on the transmission path, the following parameters can be read out:

Batterie Parameter	Bluetooth	GX device	VC-R	VRM
Balancer status	Yes			
Min and max cell voltage	Yes	Yes	Yes	Yes
Min and max cell temperature	Yes	Yes	Yes	Yes
Number of batteries	Yes	Yes	Yes	Yes
Number of battery cells	Yes	Yes	Yes	Yes
Number of batteries in series	Yes	Yes	Yes	Yes
Number of batteries in parallel	Yes	Yes	Yes	Yes
Serial number	Yes	No	No	No
Capacity	Yes	No	No	No
Firmware version	Yes	No	No	No
Battery voltage	Yes	Yes	Yes	Yes
Battery temperature	Yes	Yes	Yes	Yes
Battery current	Yes	No	No	No
Individual cell voltages	Yes	No	No	No

5.1.1. Monitoring the battery via VictronConnect

The VictronConnect app can be used to monitor the battery via Bluetooth or VC-R. The table in the previous section lists the available parameters per connection type.

To check the battery parameters, do the following

1. Open the VictronConnect app, and from the Device List, tap on the BMS that is connected to the battery.
2. Tap the Battery tab to view all battery parameters.
3. Each battery has its own page, which you can select using the battery selector marked with a red circle.

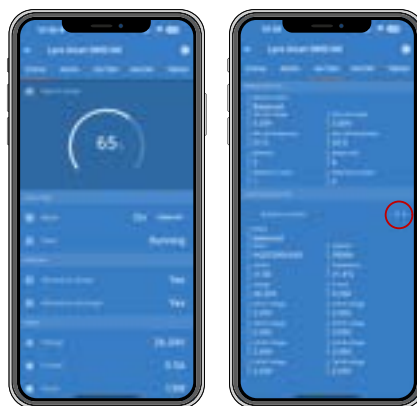

Note that warning, alarm or error messages are only shown while actively connected to the BMS via VictronConnect. The app is not active in the background nor when the screen is off.

5.1.2. Monitoring the battery via a GX device

The battery parameters can also be read out with a GX device via the Remote Console in conjunction with a Lynx Smart BMS NG. The table in the previous section lists the available parameters per connection type.

To check the battery parameters, do the following

1. Open the Remote Console, and from the Device List click on the Lynx Smart BMS NG.
2. Scroll down to 'System' and open the submenu by clicking on it to view all available battery parameters.



5.1.3. Monitoring the battery via the VRM Portal

The battery parameters can also be read out via the VRM Portal (requires a GX device in conjunction with a Lynx Smart BMS NG that transmits its data to VRM). The table in the previous section lists the available parameters per connection type.

The battery parameters can be viewed via the 'Advanced' tab. For more information, please see our [VRM Portal documentation](#).



5.2. Battery charging and discharging

This chapter describes the charging, discharging and cell balancing process in more detail for those who are interested in the technical background.

5.2.1. Charging the battery and recommended charger settings

Recommended battery chargers

Ensure your charger supplies the correct current and voltage for the battery, so do not use a 24 V charger for a 12 V battery.

It is also recommended that the charger has a charging profile/algorithm that matches the battery chemistry (LiFePO₄) or a custom profile that can be adjusted to match the appropriate charging parameters of the lithium battery. All Victron chargers ([AC Chargers](#) including [Inverter/Chargers](#), [Solar Chargers](#) and [DC-DC Chargers](#)) have these preset charging profiles built-in. Make sure this profile is selected. See also the respective charger manuals.

Recommended charger settings

The important charging parameters are absorption voltage, absorption time and float voltage.

- **Absorption voltage:** 14.2 V for a 12.8 V lithium battery (28.4 V / 56.8 V for a 24 V or 48 V system)
- **Absorption time:** 2 hours. We recommend a minimum absorption time of 2 hours per month for lightly cycled systems, such as backup or UPS applications, and 4 to 8 hours per month for more heavily cycled (off-grid or ESS) systems. This allows the balancer enough time to balance the cells properly.
- **Float voltage:** 13.5 V for a 12.8 V lithium battery (27 V / 54 V for a 24 V or 48 V system)

Some charging profiles offer a storage mode. This is not needed for a lithium battery, but if the charger has a storage mode, then set this to the same value as the float voltage.

Some chargers have a bulk voltage setting. If so, set the bulk voltage to the same value as the absorption voltage.

Temperature-compensated charging is not required for lithium batteries; Disable temperature compensation or set temperature compensation to 0 mV/°C in your battery chargers.

Recommended charging current

Even if the battery can be charged with a much higher charging current (see the [Technical data \[30\]](#) for the max. continuous charge current), we recommend a charging current of 0.5 C, which will fully recharge a completely empty battery in 2 hours. A charging current of 0.5 C for a 100 Ah battery corresponds to a charging current of 50 A.

Charging profile

A typical charging profile resulting from the above then looks like the graph below:

- After starting the charger, it takes two hours to reach the absorption voltage
- Another two hours of absorption time to give the balancer time to balance the cells properly
- At the end of the absorption time, the charging voltage is reduced to 13.5 V float voltage

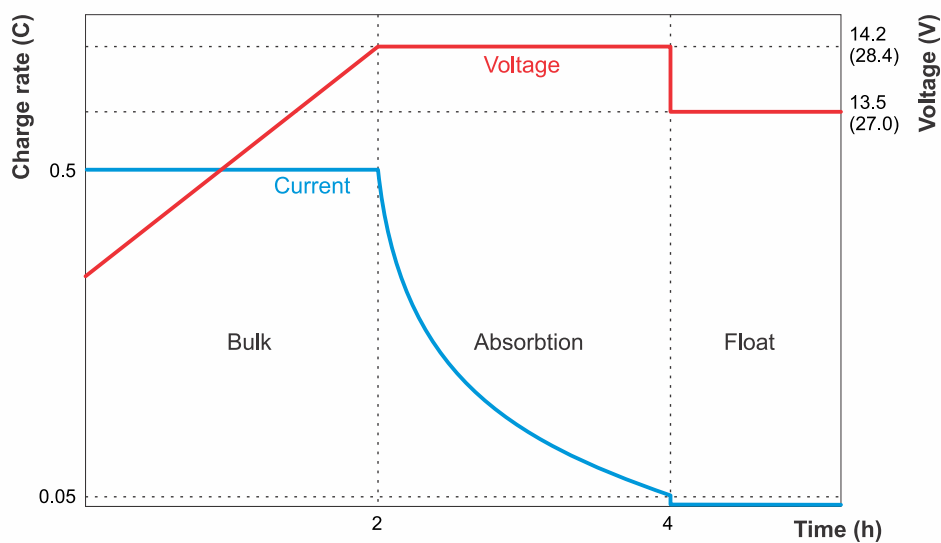

Lithium battery charge graph

5.2.2. Discharging

Even though a BMS is used, there are still a few possible scenarios in which over-discharge can damage the battery. Be sure to observe the following warning.



Lithium batteries are expensive and can be damaged due to over-discharge or overcharge.

Damage due to over-discharge can occur if small loads (such as alarm systems, relays, standby currents of certain loads, back current drain of battery chargers, or charge regulators) slowly discharge the battery when the system is not in use.

A shutdown due to a low cell voltage by the BMS should always only be used as a last resort to prevent imminent battery damage. We recommend preventing this from happening in the first place and instead using the remote on/off function of the BMS as a system on/off switch if you are leaving the system unattended for long periods of time, or even better, using a battery switch, removing the battery fuse(s) or the positive terminal of the battery when the system is not in use. Before doing this, ensure that the battery is sufficiently charged so that there is always enough reserve capacity in the battery.

A residual discharge current is especially dangerous if the system has been discharged completely and a low cell voltage shutdown has occurred. After shutdown due to low cell voltage, a capacity reserve of approximately 1Ah per 100Ah battery capacity is left in the battery. The battery will be damaged if the remaining capacity reserve is drawn from the battery; for example, a residual current of just 10 mA can damage a 200 Ah battery if the system is left discharged for more than 8 days.

If a low cell voltage disconnect has occurred, immediate action (recharge the battery) is required.

Recommended discharge current

Do not exceed the max. continuous discharge current of ≤ 1 C. When using a higher discharge rate, the battery will produce more heat than when a low discharge rate is used. More ventilation space is needed around the batteries, and depending on the installation, hot air extraction or forced air cooling might be required. Also, some cells might reach the low voltage threshold quicker than others. This can be because of a combination of elevated cell temperature and battery ageing.

Depth of Discharge (DoD)

The depth of discharge has a decisive influence on the service life of the lithium battery. The higher the depth of discharge, the lower the number of possible charge cycles. See the [Technical data \[30\]](#) for the possible number of charge cycles depending on the depth of discharge.

Effect of temperature on battery capacity

The temperature affects the battery capacity. The nominal capacity data of the respective battery model in the datasheet is based on 25 °C at a discharge rate of 1 C. These numbers are reduced by ~20 % at 0 °C and reduce even further to ~50 % at -20 °C. However, since SoC is not calculated in the battery but in the battery monitor, which therefore does not show the actual SoC, it is much more important to keep an eye on the battery and cell voltages when discharging at low temperatures.

5.3. Observe the operating conditions

The operating conditions for charging and discharging the battery must also be observed. The parameters differ depending on the battery model.

These are in detail:

- Discharge is only permitted in a temperature range of -20 °C to +50 °C. The charging rate also depends on the battery temperature. At temperatures at or below 0 °C, the discharge current must be reduced to 0.5 C. At temperatures above 35 °C, the discharge current must also be reduced. See also the diagram below.

Ensure that all loads are switched off accordingly when the temperature exceeds the limits (ideally, loads have a remote on/off port controlled by the BMS).

- Charging the battery is only allowed in a temperature range of +5 °C to +50 °C.

At temperatures below 15 °C, the charge current must be reduced to a maximum of 0.3 C. At temperatures above 35 °C, the charge current must also be reduced. See also the diagram below.

Ensure that all chargers are switched off accordingly when the minimum temperature limit is reached (ideally, the charger has a remote on/off port controlled by the BMS) to prevent charging below +5 °C or above 50 °C.

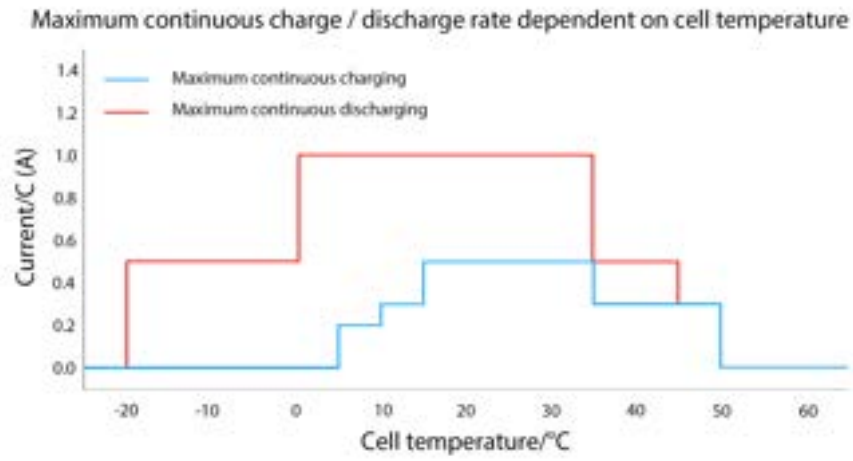

5.4. Battery care

Once the battery is in operation, it is important to take proper care of the battery to maximise its lifetime.

These are the basic guidelines:

1. Prevent total battery discharge at all times.
2. Familiarise yourself with the pre-alarm feature of the BMS and act when the pre-alarm is active to prevent a system shutdown.
3. If the pre-alarm is active or if the BMS has disabled the loads, make sure that the batteries are recharged immediately. Minimise the time the batteries are in a deep discharged state.
4. The BMS ensures that the batteries spend sufficient time in absorption at least once in a month to ensure sufficient time in balancing mode. Do not interrupt the charging process until the balancer status shows "Balanced" for each individual battery in the system.
5. When leaving the system unattended for some time, either keep the batteries charged or make sure they are (almost) full and then disconnect the DC system from the battery.

6. Troubleshooting & support

The first step in troubleshooting should be to follow the steps in this chapter for common battery issues.

If you experience problems with VictronConnect, first consult the [VictronConnect manual](#), especially the troubleshooting chapter.

Should all this fail to resolve the issue, scan through popular questions and answers regarding your product and ask the community of experts in the [Victron Community](#). In case the problem persists, contact the point of purchase for technical support. If the point of purchase is unknown, refer to the [Victron Energy Support webpage](#).

6.1. Battery issues

6.1.1. How to recognise cell imbalance

- The BMS frequently disables the charger

This is an indication that the battery is imbalanced. The charger will never be disabled by the BMS if the battery is well-balanced. Even when fully charged, the BMS will leave the charger enabled.

- The battery capacity seems to be less than before

If the BMS disables loads much sooner than it used to, even while the overall battery voltage still looks OK, this is an indication that the battery is imbalanced.

- There is a noticeable difference between the individual cell voltages during absorption stage

When the charger is in the absorption stage, all cell voltages should be equal and between 3.50V and 3.60V. If this is not the case, this is an indication that the battery is imbalanced.

- A cell slowly drops in voltage when the battery is not used

This is not an imbalance, although it might look like it. A typical example is when the battery cells initially all have equal voltages, but after a day or so of not using the battery, one of the cells has dropped 0.1 to 0.2V below the other cells. This cannot be fixed by rebalancing, and the cell is considered to be defective.

6.1.2. Causes for cell imbalance or a variation in cell voltages

1. ***The battery has not spent enough time in the absorption charge stage.***

This can, for example, happen in a system where there is not enough solar power to fully charge the battery, or in systems where the generator is not running long or often enough. During normal operation of a lithium battery, small differences between cell voltages occur all the time. These are caused by slight differences between the internal resistance and self-discharge rates of each cell. The absorption charge stage fixes these small differences. We recommend a minimum absorption time of 2 hours per month for lightly cycled systems, such as backup or UPS applications and 4 to 8 hours per month for more heavily cycled (off-grid or ESS) systems. This allows the balancer enough time to properly balance the cells.

2. ***The battery never reaches the float (or storage) stage.***

The float (or storage) stage follows the absorption stage. During this stage, the charge voltage drops to 13.5V (in a 12V system), and the battery can be considered full. If the charger never enters this stage, it might be a sign that the absorption stage has not been completed (see previous point). The charger should be allowed to reach this stage at least once a month. This is also needed for battery monitor SoC (state of charge) synchronisation.

3. ***The battery has been discharged too deeply.***

During a very deep discharge, one or more cells in the battery can drop well below their low voltage thresholds (2.60V hardcoded). The battery might be recoverable by rebalancing, but there is also a realistic chance that one or more cells are now defective and that rebalancing will not be successful. Consider the cell to be defective. This is not covered by warranty.

4. ***The battery is old and is near its maximum cycle life.***

When the battery is close to its maximum cycle life, one or more battery cells will start to deteriorate, and the cell voltage will be lower than the other cell voltages. This is not an imbalance, although it might look like it is. This cannot be fixed by rebalancing. Consider the cell defective. This is not covered by warranty.

5. ***The battery has a defective battery cell.***

A cell can become defective after a very deep discharge when it is at the end of its cycle life or because of a manufacturing fault. A defective cell is not unbalanced (although it might look like it is). It cannot be fixed by rebalancing. Consider the cell defective. Very deep discharge and end-of-cycle life are not covered by warranty.

6.1.3. How to recover an imbalanced battery

- Charge the battery using a charger configured for lithium and controlled by the BMS.
- Be aware that cell balancing only occurs during the absorption stage. Each time the charger goes to float, it must be manually restarted. Rebalancing can take a long time (up to a few days) and requires many manual charger restarts.
- Be aware that it might look like nothing is happening during cell balancing. The cell voltages can remain the same for a long time, and the BMS will repeatedly turn the charger on and off. This is all normal.
- Balancing takes place when the charge current is at or above 1.8A or when the BMS has temporarily disabled the charger.
- Balancing is almost finished when the charge current drops below 1.5A and the cell voltages are close to 3.55V.
- The rebalancing process is complete when the charge current has dropped even further, and all cells are 3.55V.



Be 100% sure that the BMS controls the charger; dangerous cell overvoltage can occur if it is not. Check this by monitoring the cell voltages using the VictronConnect app. The voltage of the fully charged cells will slowly creep up until 3.7V has been reached. At this point, the BMS will disable the charger and the cell voltages will drop again. This process will continuously repeat until the balance is restored.

Calculation example of time required to restore a heavily imbalanced battery:

Imagine a 12.8V 200Ah battery with one heavily undercharged (discharged) cell for this example.

A 12.8V battery contains 4 cells, each with a nominal voltage of 3.2V. They are connected in series, resulting in $3.2 \times 4 = 12.8V$. Like the battery, each cell has a capacity of 200Ah.

Let's say the imbalanced cell is only at 50% of its capacity while the other cells are fully charged. To restore the balance, the rebalancing process will need to add 100Ah to that cell.

The balancing current is 1.8A (per battery and all battery sizes, except for the 12.8V/50Ah model, which has a balancing current of 1A). Rebalancing the cell will take at least $100/1.8 = 55$ hours.

Balancing only takes place when the charger is in the absorption stage. If a 2-hour lithium charge algorithm is used, the charger will need to be manually restarted $55/2=27$ times during the rebalancing process. If the charger is not restarted immediately, the balancing process will be delayed, and this will add to the total balancing time.



A tip for Victron Energy distributors and professional users: To avoid having to restart the charger continuously, use the following trick. Set the float voltage at 14.2, this will have the same effect as the absorption stage. Also, disable the storage stage and/or set that to 14.2V. Or alternatively, set the absorption time to a very long time. What matters is that the charger maintains a continuous 14.2V charge voltage during the rebalancing process. After the battery has been rebalanced, set the charger back to the normal lithium charge algorithm. Never leave a charger connected like this in a running system. Keeping the battery at such a high voltage will decrease the lifetime of the battery.

6.1.4. Less capacity than expected

If the battery capacity is less than its rated capacity, these are the possible reasons for that:

- The battery's cell imbalance causes premature low-voltage alarms, which in turn causes the BMS to turn loads off.

Please refer to section [How to recover an imbalanced battery \[23\]](#).

- The battery is old and is near its maximum cycle life.

Check how long the system has been in operation, how many cycles the battery has gone through and to what average depth of discharge the battery has been discharged. A way to find this information is to look at the history of a battery monitor (if available).

- The battery has been discharged too deeply, and one or more cells in the battery are permanently damaged.

These bad cells will have a low cell voltage faster than the other cells, and this will cause the BMS to turn loads off prematurely. Has the battery perhaps been through a very deep discharge event?

6.1.5. Battery very low terminal voltage

If the battery is discharged too deeply, the voltage will fall well below 12V (24V). If the battery has a voltage of less than 10V (20V or 40V respectively for 24V and 48V batteries) or if one of the battery cells has a cell voltage below 2.5V, the battery will have permanent damage. This will invalidate the warranty. The lower the battery or cell voltage is, the more damage to the battery will be.

You can try to recover the battery by using the below low-voltage recharge procedure. Be aware that this is not a guaranteed process, recovery might be unsuccessful, and there is a realistic chance that the battery has permanent cell damage resulting in a moderate to severe capacity loss after the battery has been recovered.

Charge procedure for recovery after low voltage event:

This recovery charge procedure can only be performed on an individual battery. If the system contains multiple batteries, repeat this procedure for each individual battery.



This process can be risky. A supervisor must be present at all times.

1. Set a charger or power supply to 13.8V (27.6V, 55.2V).
2. In case any of the cell voltages is below 2.0V, charge the battery with 0.1A until the voltage of the lowest cell increases to 2.5V.
A supervisor must monitor the battery and stop the charger as soon as the battery is getting hot or bulging. If this is the case, the battery is unrecoverably damaged.
3. Once the voltage of the lowest cell has increased above 2.5V, increase the charge current to 0.1C.
For a 100Ah battery, this is a charge current of 10A.
4. Connect the battery to a BMS and ensure that the BMS has control over the battery charger.
5. Make a note of the initial battery terminal voltage and battery cell voltages.
6. Start the charger.
7. The BMS might turn the charger off, then on again for a short time and then off again.
This can occur many times over and is normal behaviour in case of a significant cell imbalance.
8. Make a note of the voltages at regular intervals.
9. The cell voltages should increase during the first part of the charging process.
If the voltage of any of the cells does not increase in the first half hour, consider the battery unrecoverable and abort the charging procedure.
10. Check the battery temperature at regular intervals.
If you see a sharp increase in temperature, consider the battery unrecoverable and abort the charging procedure.
11. Once the battery has reached 13.8V (27.6V, 55.2V), increase the charge voltage to 14.2V (28.4V, 56.8V) and increase the charge current to 0.5C.
For a 100Ah battery, this is a charge current of 50A.
12. The cell voltages will increase more slowly; this is normal during the middle part of the charge process.
13. Leave the charger connected for 6 hours.
14. Check the cell voltages; they should all be within 0.1V of each other.
If one or more cells have a much higher voltage difference, consider the battery damaged.
15. Let the battery rest for a few hours.
16. Check the voltage of the battery.
It should comfortably sit above 12.8V (25.6V, 51.2V), like 13.2V (26.4V, 52.8V) or higher. And the cell voltages should still be within 0.1V of each other.
17. Let the battery rest for 24 hours.
18. Measure the voltages again.
If the battery voltage is below 12.8V (25.6V, 51.2V) or there is a noticeable cell imbalance, consider the battery damaged beyond recovery.

6.1.6. Battery is close to end-of-cycle life or has been misused

As a battery ages, its capacity will reduce, and eventually, one or more battery cells will become faulty. Battery age is related to how many charge/discharge cycles the battery has been through. A battery can also have a reduced capacity or faulty cells if it has been misused, for example, if it has been discharged too deeply.

To determine what could have caused a battery issue, start by checking the battery history by looking at the history of a battery monitor or a Lynx Smart BMS.

To check if the battery is close to its cycle life and if the battery has been misused:

1. Connect to the BMS using the VictronConnect app.
2. Click on the History tab.
3. Find out how many charge/discharge cycles the battery has been subjected to. Battery lifetime is related to the number of cycles.
4. How deep has the battery been discharged on average? The battery will last fewer deep discharge cycles than shallow discharge cycles.
5. How deeply have the battery cells been discharged? Below 2.5 V indicates that one or more cells have been discharged too much, and the battery is probably even damaged.
6. How high were the battery cells charged? Above 3.7 V indicates that charging took place without a BMS or that the charger was not controlled by the BMS (ATC) and, therefore, continued charging uncontrollably.
7. How many synchronisations were there? The battery monitor will synchronise each time the battery is fully charged. This can be used to check if the battery receives a regular full charge.
8. What was the time since last full charge? The battery needs to be fully charged at least once a month.
9. Is the battery wet? The battery is not waterproof and is not suitable for outdoor use.
10. Has the battery been mounted in its correct position? The battery can be mounted either upright or on its side, but not with the battery poles facing down.
11. Is there mechanical damage to the battery, its terminals or the BMS cables? Mechanical damage voids the warranty.
12. Is the BMS connected and functional? Not using the battery with a Victron Energy-approved BMS for Lithium NG batteries voids the warranty.

For more info on the life cycle see chapter [Technical data](#).

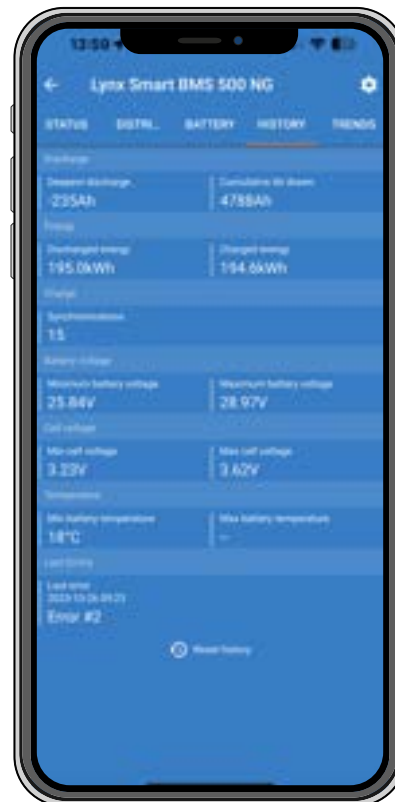

6.2. BMS issues

6.2.1. The BMS frequently disables the battery charger

- A well-balanced battery does not disable the charger, even when it is fully charged. However, when the BMS frequently disables the charger, this indicates cell imbalance.

Check the cell voltages of all batteries connected to the BMS using VictronConnect.

In case of moderate or large cell imbalance, it is expected behaviour that the BMS frequently disables the battery charger. This is the mechanism behind this behaviour:

As soon as one cell reaches 3.75V, the BMS disables the charger. Whilst the charger is disabled, the cell balancing process still continues, moving energy from the highest cell into adjacent cells. The highest cell voltage will drop; once it has fallen below 3.6V, the charger will be enabled again. This cycling typically takes between one and three minutes. The voltage of the highest cell will rise again quickly (this can be in a matter of seconds), after which the charger will be disabled again, and so forth. This does not indicate a problem with the battery or the cells. This behaviour will continue until all cells are fully charged and balanced. This process might take several hours. It depends on the level of imbalance. This process can take up to 12 hours in case of serious imbalance. Balancing will continue throughout this process, even when the charger is disabled. The continued enabling and disabling of the charger can appear strange but rest assured that there is no problem. The BMS is merely protecting the cells from overvoltage.

6.2.2. The BMS is prematurely turning chargers off

- This could be because of a cell imbalance. One cell in the battery has a cell voltage above 3.75V.

Check the cell voltages of all batteries connected to the BMS.

6.2.3. The BMS is prematurely turning loads off

- This could be because of a cell imbalance.
- When a cell's voltage falls below the battery's minimum limit of 2.6V, the BMS turns off the load.
- Check the cell voltages of all batteries connected to the BMS using the VictronConnect app.



Once the loads have been turned off due to low cell voltage, the cell voltage of all cells needs to be 3.2V or higher before the BMS will turn the loads back on.

6.2.4. The BMS is displaying an alarm while all cell voltages are within range

- A possible cause is a loose or damaged BMS cable or connector.

Check all BMS cables and their connections.

First, check that the cell voltages and temperatures of all connected batteries are within range. If they are all in range, then follow one of the following procedures.

Also consider that once there has been a cell undervoltage alarm, the cell voltage of all cells needs to be increased to 3.2V before the battery clears the undervoltage alarm.

A way to rule out if a fault is originating from a faulty BMS or a faulty battery is to check the BMS using one of the following BMS test procedures:

Single battery and BMS check:

1. Disconnect both BMS cables from the BMS.
2. Connect a single BMS extension cable between both BMS cable connectors. The BMS cable should be connected in a loop, as shown in the diagram below. The loop tricks the BMS into thinking that a battery is connected without any alarms.

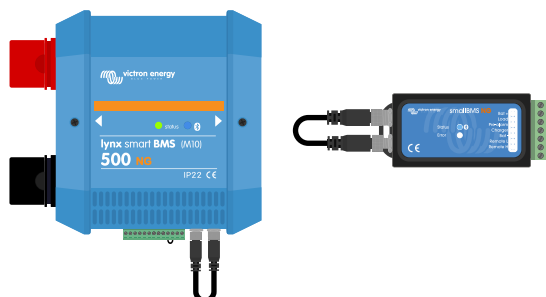

The BMS is faulty if the alarm is still active after the loop has been placed.

If the BMS has cleared the alarm after the loop has been placed, the battery is faulty.

Multiple batteries and BMS check:

1. Bypass one of the batteries by disconnecting both its BMS cables
2. Connect the BMS cables of the neighbouring batteries (or battery and BMS) to each other, effectively bypassing the battery.
3. Check if the BMS has cleared its alarm.

Repeat this for the next battery if the alarm has not been cleared.

The BMS is faulty if the alarm is still active after all batteries have been bypassed.

If the BMS clears its alarm when a particular battery is bypassed, that particular battery is faulty.



Eliminating a BMS error by bypassing a suspect battery

6.2.5. How to test if the BMS is functional

Disconnect one of the battery BMS cables and see if the BMS will go into alarm mode.



Check BMS functionality by deliberately disconnecting a BMS cable

7. Warnings, alarms and errors

7.1. E-SL1: Balancer failure



Contact your dealer or distributor to resolve this situation.

7.2. W-SL11: Under voltage warning (pre-alarm)

- The voltage of one or more cells is becoming too low and has dropped below the pre-alarm setting.



To remedy this warning, recharge the battery as soon as possible.

7.3. A-SL9 Over voltage alarm

- The voltage of one or more cells has become too high.



Immediately disable all chargers and contact the system installer to check that all chargers are properly controlled by the "charge disconnect" contact on the BMS. When properly controlled, a high voltage situation is not possible, as the BMS disconnects all chargers well before raising the high voltage alarm.

7.4. A-SL11: Under voltage alarm

- The voltage of one or more cells is below the configured Allow-To-Discharge cell voltage and discharging has been disabled



To remedy this warning, recharge the battery as soon as possible.

7.5. A-SL15: Over temperature alarm

- The battery has reached its high-temperature threshold and charging is disabled.



Provide adequate ventilation and make sure there is enough space around the battery. Reduce charging current and/or loads.

7.6. A-SL22: Under temperature alarm

- The battery has reached its low-temperature threshold and charging is disabled.



As soon as the temperature rises above the set threshold, the charging process will continue.

7.7. E-SL2: Internal communication failure



Contact your dealer or distributor to resolve this situation.

7.8. E-SL9: Overlapped voltage error



Contact your dealer or distributor to resolve this situation.

7.9. E-SL10: Balancer update error



Contact your dealer or distributor to resolve this situation.

7.10. E-SL24: Hardware failure

This error is generated in the following circumstances:

1. One (or more) cells are very deeply discharged or defective.



Check the battery terminal voltage. If the battery terminal voltage is too low, refer to the [Battery very low terminal voltage](#) chapter on what to do next.

2. The internal circuit board has a hardware fault.



To resolve this, contact your Victron Energy dealer or distributor.



To resolve a "hardware failure" error, always first refer to the [Troubleshooting & support](#) chapter of this manual before contacting your Victron Energy dealer or distributor. This is to rule out the first two possible causes of this error. Do not just assume that a hardware failure causes the error.

7.11. E-SL119: Settings data lost

- The settings data in the battery memory has been lost.



To remedy this, go to the settings page and reset settings to factory defaults.

If this error is not resolved after a settings reset, contact your Victron Energy dealer or distributor and ask for this issue to be escalated to Victron Energy, as this error should never happen. Please include the battery's serial number and firmware version.

8. Technical data

8.1. Battery specification

VOLTAGE AND CAPACITY	
Battery model	LFP 51,2 V/100 Ah
Nominal voltage	51,2 V
Nominal capacity @ 25 °C*	100 Ah
Nominal energy @ 25 °C*	5120 Wh
Capacity loss	(per 100 cycles, @ 25 °C, 100 % DoD): <1 %
Energy loss	(per 100 cycles, @ 25 °C, 100 % DoD): <1 %
Round trip efficiency	92 %
* Discharge current \leq 1C	
CYCLE LIFE (capacity \geq 80% of nominal)	
80 % DoD	2500 cycles
70 % DoD	3000 cycles
50 % DoD	5000 cycles
DISCHARGE	
Max continuous discharge current (C-rate)	100 A (1C)
Max pulse discharge current 10s (C-rate)	200 A (2C)
End of discharge voltage	44,8 V
Internal resistance	8 m Ω
CHARGE	
Charge voltage	Between 56 V and 56,8 V
Float voltage	54 V
Max continuous charge current (C-rate)	100 A (1C)
Max pulse charge current 10s (C-rate)	200 A (2C)
GENERAL	
BMS-es	Lynx Smart BMS NG 500 A / 1000 A (M10 busbars), must be purchased separately
Cell measurements	Cell voltages and temperatures, battery current
Battery BMS interface	Male + female cable with M8 circular connector with high-speed digital communication, length 50 cm M8 extension cables are available separately for purchase in various lengths between 1 and 5 meters
Alarm feature	Pre-alarm contact on BMS
Bluetooth	In the BMS
Max batteries per BMS	50 (384 kWh per BMS ³⁾)
Battery firmware updates	Battery firmware automatically updated by BMS
Repairable	Yes (cover can be removed with screws)
OPERATING CONDITIONS	
Operating temperature	Discharge: -20 °C to +50 °C Charge: +5 °C to +50 °C

Storage temperature	-45 °C to +70 °C
Humidity (non-condensing)	Max. 95 %
Protection class	IP65
MOUNTING	
Mounting options	Strap or mounting brackets (bracket included)
Can be placed on their sides	Yes ²⁾
OTHER	
Self-discharge rate	≤ 3 % per month @ 25 °C
Power connection	M8 (threaded inserts and bolts)
Dimensions (h x w x d) (mm)	235 x 648 x 162
Weight (est.)	37 kg
STANDARDS	
Safety	Cells: UL1973 UL9540A IEC62619 (all three pending)
	Battery: IEC62619 (pending)
EMC	EN 61000-6-3, EN 61000-6-2
Automotive	ECE R10-6 (pending)
Performance	IEC 62620 (pending)
¹⁾ When fully charged ²⁾ The lithium battery can be mounted upright and on its side, but not with the battery terminals facing down ³⁾ Up to 5 BMS-es can be paralleled. This requires a firmware update, expected in Q3 2024.	

8.2. Enclosure dimensions

