

MultiPlus Compact

12 | 2000 | 80-50 120V

24 | 2000 | 50-50 120V

1. IMPORTANT SAFETY INSTRUCTIONS - SAVE THESE INSTRUCTIONS!

WARNING— These servicing instructions are for use by qualified personnel only. To reduce the risk of electric shock, do not perform any servicing other than that specified in the operating instructions unless you are qualified to do so.

General

Please familiarize yourself with the safety features and instructions by first reading the documentation supplied with this product before using the equipment. This product has been designed and tested in accordance with international standards. The equipment must be used exclusively for the purpose for which it was designed.

WARNING: ELECTRIC SHOCK HAZARD.

The product is used in conjunction with a permanent energy source (battery). Input and/or output terminals may still be dangerously energized, even when the equipment is switched off. Always switch off the AC supply and the battery before carrying out maintenance or servicing the product.

The product has no internal user-serviceable components. Do not remove the front plate or operate the product if any panels have been removed. All servicing must be undertaken by qualified personnel.

Never use the product where there is a risk of gas or dust explosions. Consult the battery manufacturer's information to ascertain that the product is intended for use in conjunction with the battery. Always comply with the battery manufacturer's safety instructions.

WARNING: Do not lift heavy loads without assistance.

Installation

Read the installation instructions in the installation manual before installing the equipment.

This is a Safety Class I product (supplied with a protective grounding terminal).

Uninterruptible protective grounding must be provided at the AC input and/or output terminals. Alternatively the grounding point located externally on the product may be used. Whenever it is likely that the grounding protection has been damaged, the product must be turned off and secured against unintended operation; please contact qualified service staff.

Ensure that the DC and AC input cables are fused and fitted with circuit breakers. Never replace a safety component with a different type. Consult the manual to determine the correct component.

The installation shall be in accordance with the Canadian Electrical Code, Part 1. The wiring methods shall be in accordance with the National Electrical Code, ANSI/NFPA 70.

Before applying power, ensure that the available power source matches the configuration settings of the product as described in the manual.

Ensure that the equipment is used under the correct ambient conditions. Never operate the product in a wet or dusty environment. Ensure there is adequate free space for ventilation around the product and check that the ventilation vents are not blocked.

Ensure that the required system voltage does not exceed the product's capacity.

Transport and Storage

Ensure that the mains power and battery leads have been disconnected before storing or transporting the product.

No liability can be accepted for any transport damage if the equipment is shipped in non-original packaging.

Store the product in a dry environment; the storage temperature must be between -20°C and 60°C.

Consult the battery manufacturer's manual in respect of transport, storage, charging, recharging and disposal of the battery.

2. DESCRIPTION

2.1 General

Multi Compact -functional

The MultiPlus Compact gets its name from the multiple functions it can perform. It is a powerful true sine wave inverter, a sophisticated battery charger that features adaptive charge technology and a high-speed AC transfer switch in a single compact enclosure. Beside these primary functions, however, the MultiPlus Compact has several advanced features that provide a range of new applications as outlined below.

Uninterrupted AC power

In the event of a grid failure, or shore or generator power being disconnected, the inverter within the Multi Compact is automatically activated and takes over supply to the connected loads. This happens so fast (less than 20 milliseconds) that computers and other electronic equipment will continue to operate without disruption.

PowerControl – Dealing with limited generator or shore side power

With a Phoenix Multi Control Panel a maximum generator or shore current can be set. The Multi Compact will then take account of other AC loads and use whatever is extra for charging, thus preventing the generator or shore supply from being overloaded.

PowerAssist – Boosting the capacity of shore or generator power

This feature takes the principle of PowerControl to a further dimension allowing the MultiPlus Compact to supplement the capacity of the alternative source. Where peak power is so often required only for a limited period, it is possible to reduce the size of generator needed or conversely enable more to be achieved from the typically limited shore connection. When the load reduces, the spare power is used to recharge the battery.

Programmable relay

The MultiPlus is equipped with a programmable relay that by default is set as an alarm relay. The relay can be programmed for all kinds of other applications however, for example as a starter relay for a generator.

2.2 Battery charger

Adaptive 4-stage charging characteristics: bulk – absorption – float – storage

The microprocessor-driven adaptive battery management system can be adjusted for various types of batteries. The adaptive function automatically adapts the charging process to battery use.

The right amount of charge: variable absorption time

In the event of slight battery discharge, absorption is kept short to prevent overcharging and excessive gas formation. After deep discharging, the absorption time is automatically extended in order to fully charge the battery.

Preventing damage due to excessive gassing: the BatterySafe mode

If, in order to quickly charge a battery, a high charge current in combination with a high absorption voltage has been chosen, damage due to excessive gassing will be prevented by automatically limiting the rate of voltage increase once the gassing voltage has been reached.

Less maintenance and aging when the battery is not in use: the Storage mode

The Storage mode kicks in whenever the battery has not been subjected to discharge during 24 hours. In the Storage mode float voltage is reduced to 2,2V/cell (13,2V for 12V battery) to minimise gassing and corrosion of the positive plates. Once a week the voltage is raised back to the absorption level to 'equalize' the battery. This feature prevents stratification of the electrolyte and sulphation, a major cause of early battery failure.

Two DC outputs for charging two batteries

The main DC terminal can supply the full output current. The second output, intended for charging a starter battery, is limited to 4A and has a slightly lower output voltage.

Increasing service life of the battery: temperature compensation

The temperature sensor (supplied with the product) serves to reduce charging voltage when battery temperature rises. This is particularly important for maintenance-free batteries, which could otherwise dry out by overcharging.

More on batteries and charging

Our book 'Energy Unlimited' offers further information on batteries and battery charging and is available free of charge on our website (see www.victronenergy.com -> Support & Downloads' -> General Technical Information). For more information on adaptive charging, please also refer to the General Technical Information our website.

2.3 Self consumption – solar energy storage systems

When the Multi/Quattro is used in a configuration in which it will feed back energy to the grid it is required to enable grid code compliance by selecting the grid code country setting with the VEConfigure tool.

This way the Multi/Quattro can comply to the local rules.

Once set, a password will be required to disable grid code compliance or change grid code related parameters.

If the local grid code is not supported by the Multi/Quattro an external certified interface device should be used to connect the Multi/Quattro to the grid.

Special note for Australian customers: IEC62109.1 certification and CEC approval for off-grid use does NOT imply approval for grid-interactive installations. Additional certification to IEC 62109.2 and AS 4777.2.2015 are required before grid-interactive systems can be implemented. Please check Clean Energy Council website for current approvals.

3. OPERATION

3.1 On/Off/Charger Only Switch

When switched to "on", the product is fully functional. The inverter will come into operation and the LED "inverter on" will light up.

An AC voltage connected to the "AC in" terminal will be switched through to the "AC out" terminal, if within specifications. The inverter will switch off, the "mains on" LED will light up and the charger commences charging. The "bulk", "absorption" or "float" LEDs will light up, depending on the charger mode. If the voltage at the "AC-in" terminal is not within specifications, the inverter will switch on.

When the switch is switched to "charger only", only the battery charger of the Phoenix Multi will operate (if mains voltage is present). In this mode input voltage also is switched through to the "AC out" terminal.

NOTE: When only the charger function is required, ensure that the switch is switched to "charger only". This prevents the inverter from being switched on if the mains voltage is lost, thus preventing your batteries from running flat.

3.2 Remote control

Remote control is possible with a 3-way switch or with a Multi Control panel.

The Multi Control panel has a simple rotary knob with which the maximum current of the AC input can be set: see PowerControl and PowerAssist in Section 2.

For the appropriate DIP switch settings, see sect. 5.5.1.

3.3 Equalisation and forced absorption

3.3.1 Equalisation

Traction batteries may require regular equalisation charging. In the equalisation mode, the MultiPlus will charge with increased voltage for one hour (1V above the absorption voltage for a 12V battery, 2V for a 24V battery). The charging current is then limited to 1/4 of the set value. The "bulk" and "absorption" LEDs flash intermittently.



Equalisation mode supplies a higher charging voltage than most DC consuming devices can cope with. These devices must be disconnected before additional charging takes place.

3.3.2 Forced absorption

Under certain circumstances, it can be desirable to charge the battery for a fixed time at absorption voltage level. In Forced Absorption mode, the MultiPlus will charge at the normal absorption voltage level during the set maximum absorption time. The "absorption" LED will be 'on'.

3.3.3 Activating equalisation or forced absorption

The MultiPlus can be put into both these states from the remote panel as well as with the front panel switch, provided that all switches (front, remote and panel) are set to “on” and no switches are set to “charger only”.

In order to put the MultiPlus in this state, the procedure below should be followed.

If the switch is not in the required position after following this procedure, it can be switched over quickly once. This will not change the charging state.

NOTE: Switching from “on” to “charger only” and vice versa, as described below, must be done quickly. The switch must be toggled such that the intermediate position is ‘skipped’, as it were. If the switch remains in the “off” position even for a short time, the device may be turned off. In that case, the procedure must be restarted at step 1. A certain degree of familiarisation is required when using the front switch on the Compact in particular. When using the remote panel, this is less critical.

Procedure:

1. Check whether all switches (i.e. front switch, remote switch or remote panel switch if present) are in the “on” position.
2. Activating equalisation or forced absorption is only meaningful if the normal charging cycle is completed (charger is in ‘Float’).
3. To activate:
 - a. Switch rapidly from “on” to “charger only” and leave the switch in this position for ½ to 2 seconds.
 - b. Switch rapidly back from “charger only” to “on” and leave the switch in this position for ½ to 2 seconds.
 - c. Switch once more rapidly from “on” to “charger only” and leave the switch in this position.
4. On the MultiPlus the three LEDs “Inverter”, “Charger” and “Alarm” will now flash 5 times. If a MultiControl panel is connected, on the panel the LEDs “bulk”, “absorption” and “float” will also flash 5 times.
5. Subsequently, on the MultiPlus the LEDs “Bulk”, “Absorption” and “Float” will each light during 2 seconds. If a MultiControl panel is connected, on the panel the LEDs “bulk”, “absorption” and “float” will also each light during 2 seconds.
6.
 - a. If the switch on the MultiPlus is set to “on” while the “Bulk” LED lights, the charger will switch to equalisation. Similarly, if the switch on the MultiControl panel is set to “on” while the “Bulk” LED lights, the charger will switch to equalisation.
 - b. If the switch on the MultiPlus is set to “on” while the “Absorption” LED lights, the charger will switch to forced absorption. Similarly, if the switch on the MultiControl panel is set to “on” while the “Absorption” LED lights, the charger will switch to forced absorption.
 - c. If the switch on the MultiPlus is set to “on” after the three LED sequence has finished, the charger will switch to “Float”. Similarly, if the switch on the MultiControl panel is set to “on” after the three LED sequence has finished, the charger will switch to “float”.
 - d. If the switch is has not been moved, the MultiPlus will remain in ‘charger only’ mode and switch to “Float”.

3.4 LED Indications

- LED off
- ☀ LED flashes
- LED illuminated

Inverter

inverter	●		<u>on</u>
charger	○		off
alarm	○		charger only

The inverter is switched on and supplies power to the load. Battery operation.

inverter	●		<u>on</u>
charger	○		off
alarm	☀		charger only

The inverter is switched on and supplies power to the load.
Pre alarm: overload, or battery voltage low, or inverter temperature high

inverter	●		<u>on</u>
charger	○		off
alarm	●		charger only

The inverter is switched off.
Alarm: overload, or battery voltage low, or inverter temperature high, or DC ripple voltage was too high.

Charger

inverter	○		<u>on</u>
charger	●		off
alarm	○		charger only

The AC input voltage is switched through and the charger operates in bulk or absorption mode.

inverter	●		<u>on</u>
charger	●		off
alarm	●		charger only

The AC input voltage is switched through and the charger is switched off.
The battery charger can not reach battery end voltage (bulk protection mode).

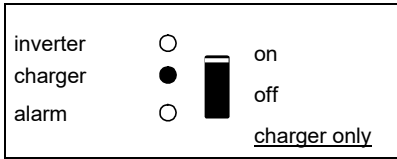

The AC input voltage is switched through and the charger operates in bulk or absorption mode.

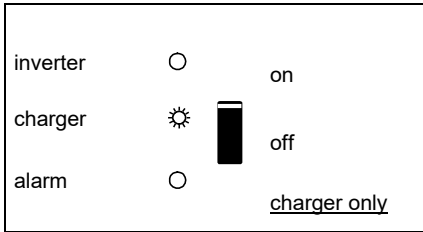

The AC input voltage is switched through and the charger operates in float mode.

Remote Control panel (optional)

Power Control and PowerAssist indication

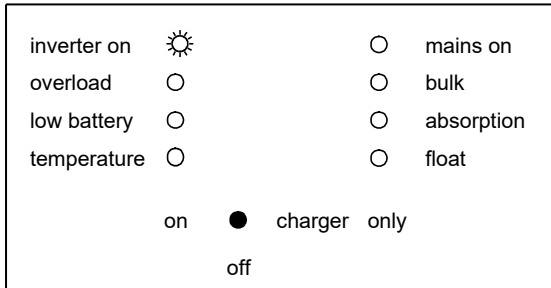

Note: When the LED's "overload" and "low battery" are on simultaneously, the Multi(Plus) or Inverter Compact has switched off due to excessive DC ripple voltage.

4. INSTALLATION



This product should be installed by a qualified electrician.









4.2 Location

The product must be installed in a dry and well-ventilated area, as close as possible to the batteries. There should be a clear space of at least 10cm around the appliance for cooling. The product is suitable for wall mounting. For mounting see appendix A.

The appliance can be mounted horizontally as well as vertically; vertical mounting is preferable. The vertical position offers optimum cooling.

Try and keep the distance between the product and the battery to a minimum in order to minimize cable voltage losses.

	<p>Excessively high ambient temperature will result in the following: Reduced service life. Reduced charging current. Reduced peak capacity, or shutdown of the inverter. Never mount the appliance directly above the batteries.</p>
	<p>The interior of the product must remain accessible after installation.</p>
	<p>For safety purposes, this product should be installed in a heat-resistant environment if it is used with equipment where a substantial amount of power is to be converted. You should prevent the presence of e.g. chemicals, synthetic components, curtains or other textiles, etc., in the immediate vicinity.</p>
	<p>CAUTION- Do not expose charger to rain or snow</p>





	<p>Each system requires a method of disconnecting the AC and DC circuits. If the overcurrent protection device is a circuit breaker, it will also serve as the disconnect. If fuses are used, separate disconnect switches will be needed between the source and the fuses.</p>
	<p>To reduce the risk of fire, do not connect to an ac load center (circuit breaker panel) having multiwire branch circuits connected.</p>
	<p>CAUTION – To reduce risk of injury, charge only Lead Acid or LIFEPO4 type rechargeable batteries. Other types of batteries may burst causing personal injury and damage.</p>
	<p>Use of an attachment not recommended or sold by the marine unit manufacturer may result in a risk of fire, electric shock, or injury to persons</p>
	<p>Do not disassemble marine unit; take it to a qualified serviceman when service or repair is required. Incorrect reassembly may result in a risk of electric shock or fire.</p>
	<p>To reduce risk of electric shock, unplug marine unit from outlet before attempting any maintenance or cleaning. Turning off controls will not reduce this risk.</p>
	<p>WARNING – RISK OF EXPLOSIVE GASES) WORKING IN VICINITY OF A LEAD-ACID BATTERY IS DANGEROUS.</p> <p>BATTERIES GENERATE EXPLOSIVE GASES DURING NORMAL BATTERY OPERATION. FOR THIS REASON, IT IS OF UTMOST IMPORTANCE THAT EACH TIME BEFORE SERVICING THE UNIT IN THE VICINITY OF THE BATTERY, YOU READ THIS MANUAL AND FOLLOW THE INSTRUCTIONS EXACTLY.</p>
	<p>To reduce risk of battery explosion, follow these instructions and those published by battery manufacturer and manufacturer of any unit you intend to use in vicinity of battery. Review cautionary marking on these products and on engine.</p>



PERSONAL PRECAUTIONS

- i. Someone should be within range of your voice or close enough to come to your aid when you work near a lead-acid battery.
- ii. Have plenty of fresh water and soap nearby in case battery acid contacts skin, clothing, or eyes.
- iii. Wear complete eye protection and clothing protection. Avoid touching eyes while working near battery.
- iv. If battery acid contacts skin or clothing, wash immediately with soap and water. If acid enters eye, immediately flood eye with running cold water for at least 10 min and get medical attention immediately.
- v. NEVER smoke or allow a spark or flame in vicinity of battery or engine.
- vi. Be extra cautious to reduce risk of dropping a metal tool onto battery. It might spark or short-circuit battery or other electrical part that may cause explosion.
- vii. Remove personal metal items such as rings, bracelets, necklaces, and watches when working with a lead-acid battery. A lead-acid battery can produce a short-circuit current high enough to weld a ring or the like to metal, causing a severe burn.
- viii. NEVER charge a frozen battery.
- ix. If necessary to remove battery from vessel, always remove grounded terminal from battery first. Make sure all accessories in the vessels are off, so as not to cause an arc.
- x. Be sure area around battery is well ventilated.
- xi. Clean battery terminals. Be careful to keep corrosion from coming in contact with eyes.
- xii. Study all battery manufacturer's specific precautions such as removing or not removing cell caps while charging and recommended rates of charge.
- xiii. Add distilled water in each cell until battery acid reaches level specified by battery manufacturer. This helps purge excessive gas from cells. Do not overfill. For a battery without cell caps, carefully follow manufacturer's recharging instructions.

MARINE UNIT LOCATION

	<ul style="list-style-type: none"> • Locate marine unit away from battery in a separate, well ventilated compartment. • Never place marine unit directly above battery; gases from battery will corrode and damage marine unit. • Never allow battery acid to drip on marine unit when reading gravity or filling battery. • Do not operate marine unit in a closed-in area or restrict ventilation in any way.
	<p>DC CONNECTION PRECAUTIONS</p> <p>Connect and disconnect DC output connections only after setting any marine unit switches to off position and removing AC cord from electric outlet or opening AC disconnect.</p>
	<p>EXTERNAL CONNECTIONS TO CHARGER SHALL COMPLY WITH THE UNITED STATES COAST GUARD ELECTRICAL REGULATIONS (33CFR183, SUB PART I).</p>
	<p>GROUNDING INSTRUCTIONS – This marine unit should be connected to a grounded, metal, permanent wiring system; or an equipment-grounding conductor should be run with circuit conductors and connected to equipment-grounding terminal or lead on unit.</p> <p>Connections to unit should comply with all local codes and ordinances.</p>

4.2 Connection of Battery cables

In order to fully utilize the full capacity of the product, batteries with sufficient capacity and battery cables with sufficient cross section should be used. The DC cables must be copper and rated 90°C (194°F) See table.

	12/2000/80-50	24/2000/50-50
Recommended battery capacity (Ah)	350–1000	200–500
Recommended DC fuse	300A	200A
Recommended cross section (mm ²) per + and - connection terminal		
0 – 5m	70mm ²	35mm ²

Remark: Internal resistance is the important factor when working with low capacity batteries. Please consult your supplier or the relevant sections of our book “electricity on board”, downloadable from our website.

Procedure

Proceed as follows to connect the battery cables:



Use an insulated box spanner in order to avoid shorting the battery.
Avoid shorting the battery cables.

Connect the battery cables: the + (red) on the left and the - (black) on the right, to the battery see appendix A.

Reverse polarity connection (+ to – and – to +) will cause damage to the product. (Safety fuse inside the Multi Compact can be damaged)

Secure the nuts tightly in order to reduce the contact resistance as much as possible.

4.3 Connection of the AC cabling

This is a Safety Class I product (supplied with a protective grounding terminal). **Uninterruptible protective grounding must be provided at the AC input and/or output terminals and/or chassis grounding point located externally on the product.**



The MultiPlus is provided with a ground relay (relay H, see appendix B) that **automatically connects the Neutral output to the chassis if no external AC supply is available**. If an external AC supply is provided, the ground relay H will open before the input safety relay closes. This ensures the correct operation of an earth leakage circuit breaker that is connected to the output.

- In a fixed installation, an uninterruptable grounding can be secured by means of the grounding wire of the AC input. Otherwise the casing must be grounded.
- In a mobile installation (for example, with a shore current plug), interrupting the shore connection will simultaneously disconnect the grounding connection. In that case, the casing must be connected to the chassis (of the vehicle) or to the hull or grounding plate (of the boat).

In case of a boat, direct connection to the shore ground is not recommended because of potential galvanic corrosion. The solution to this is using an isolation transformer.

The mains -input & output terminal connector can be found on the bottom of the Multi Compact, see appendix A.

- **AC-in**
The AC input must be protected by a fuse or magnetic circuit breaker rated at 50A or less, and cable cross-section must be sized accordingly. If the input AC supply is rated at a lower value, the fuse or magnetic circuit breaker should be downsized accordingly.
- **AC-out**
With its PowerAssist feature the Multi can add up to 2kVA (that is $2000 / 120 = 17A$) to the output during periods of peak power requirement. Together with a maximum input current of 50A this means that the output can supply up to $50 + 17 = 67A$.
An earth leakage circuit breaker and a fuse or circuit breaker rated to support the expected load must be included in series with the output, and cable cross-section must be sized accordingly. Victron Energy recommends to use the Blue Sea systems GFCI circuit breakers PN. 309X or 310X

4.4 Optional Connections

A number of optional connections are possible:
Undo the four screws at the front of the enclosure and remove the front panel.

4.4.1 Second Battery

The MultiPlus Compact has a connection (+) for charging a starter battery. For connection see appendix A.

4.4.2 Temperature Sensor

The temperature sensor supplied with the product may be used for temperature-compensated charging. The sensor is insulated and must be mounted on the batteries minus pole. Default output voltages for Float and Absorption are at 25°C. In adjust mode temperature compensation is disabled.

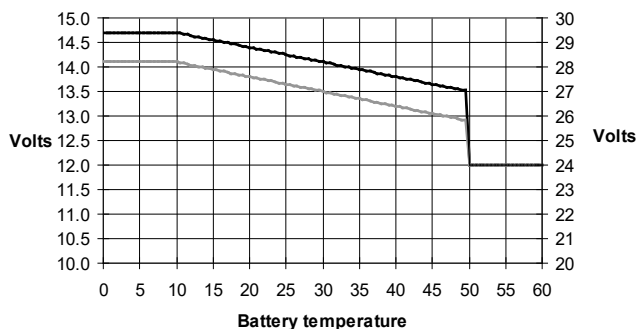

4.4.3 Remote Control

The product can be remotely controlled in two ways:

- With an external 3-way switch
- With a Multi Control Panel

Please see section 5.5.1. for appropriate DIP switch settings.

4.4.4. Programmable relay

The MultiPlus is equipped with a multi-functional relay that by default is programmed as an alarm relay. The relay can be programmed for all kinds of other applications however, for example to start a generator (VEConfigure software needed).

Near the connection terminals an LED illuminates when the relay is activated (refer to S, see appendix A).

4.4.5 Parallel Connection

The MultiPlus can be connected in parallel with several identical devices. To this end, a connection is established between the devices by means of standard RJ45 UTP cables. The system (one or more Multis plus optional control panel) will require subsequent configuration (see Section 5).

In the event of connecting MultiPlus units in parallel, the following requirements must be met:

- A maximum of six units connected in parallel.
- Only identical devices may be connected in parallel.
- The DC connection cables to the devices must be of equal length and cross-section.
- If a positive and a negative DC distribution point is used, the cross-section of the connection between the batteries and the DC distribution point must at least equal the sum of the required cross-sections of the connections between the distribution point and the MultiPlus units.
- Place the MultiPlus units close to each other, but allow at least 10 cm for ventilation purposes under, above and beside the units.
- UTP cables must be connected directly from one unit to the other (and to the remote panel). Connection/splitter boxes are not permitted.
- A battery-temperature sensor need only be connected to one unit in the system. If the temperature of several batteries is to be measured, you can also connect the sensors of other MultiPlus units in the system (with a maximum of one sensor per MultiPlus). Temperature compensation during battery charging responds to the sensor indicating the highest temperature.
- If more than three units are connected in parallel in one system, a dongle is required (see Section 5).
- Only one remote control means (panel or switch) can be connected to the system.

4.4.6 Three-phase operation

The MultiPlus can also be used in 3-phase wye (Y) configuration. To this end, a connection between the devices is made by means of standard RJ45 UTP cables (the same as for parallel operation). The system (Multis plus an optional control panel) will require subsequently configuration (see Section 5).

Pre-requisites: see Section 4.4.6.

Note: the MultiPlus is not suitable for 3-phase delta (Δ) configuration.

5. CONFIGURATION



Settings may only be changed by a qualified engineer
Carefully read the instructions before changes are made.
Batteries should be placed in a dry and well-ventilated area during charging.

5.1 Standard settings: ready for use

On delivery, the MultiPlus is set to standard factory values. In general, these settings are suitable for single-unit operation.

Warning: Possibly, the standard battery charging voltage is not suitable for your batteries! Refer to the manufacturer's documentation, or to your battery supplier!

Standard MultiPlus factory settings

Inverter frequency	60 Hz
Input frequency range	45 - 65 Hz
Input voltage range	94 - 143 VAC
Inverter voltage	120 VAC
Stand-alone / parallel / 3-phase	stand-alone
Search mode	off
Ground relay	on
Charger on/ off	on
Battery charge curve	four-stage adaptive with BatterySafe mode
Charge current	75% of the maximum charge current
Battery type	Victron Gel Deep Discharge (also suitable for Victron AGM Deep Discharge)
Automatic equalisation charging	off
Absorption voltage	14.4 / 28.8v
Absorption time	up to 8 hours (depending on bulk time)
Float voltage	13.8 / 27.6V
Storage voltage	13.2 / 26.4V (not adjustable)
Repeated absorption time	1 hour
Absorption repeat interval	7 days
Bulk protection	on
AC input current limit	30A (= adjustable current limit for PowerControl and PowerAssist functions)
UPS feature	on
Dynamic current limiter	off
WeakAC	off
BoostFactor	2
PowerAssist	on
Programmable relay	alarm function

5.2 Explanation of settings

Settings that are not self-explanatory are described briefly below. For further information, please refer to the help files in the software configuration programs (see Section 5.3).

Inverter frequency

Output frequency if no AC is present at the input.

Adjustability: 50Hz; 60Hz

Input frequency range

Input frequency range accepted by the MultiPlus. The MultiPlus synchronises within this range with the AC input frequency. The output frequency is then equal to the input frequency.

Adjustability: 45 – 65 Hz; 45 – 55 Hz; 55 – 65 Hz

Input voltage range

Voltage range accepted by the MultiPlus. The MultiPlus synchronises within this range with the AC input voltage. The output voltage is then equal to the input voltage.

Adjustability:

Lower limit: 94 - 120V

Upper limit: 120 - 143V

Inverter voltage

Output voltage of the MultiPlus in battery operation.

Adjustability: 95 – 128V

Stand-alone / parallel operation / 2-3 phase setting

Using several devices, it is possible to:

- increase total inverter power (several devices in parallel)
- create a split-phase system
- create a 3-phase system.

The standard product settings are for standalone operation. For parallel, three phase or split phase operation see section 4.4.5 and 4.4.6.

Search Mode (Applicable in stand-alone configuration only)

If search mode is 'on', the power consumption in no-load operation is decreased by approx. 70%. In this mode the Compact, when operating in inverter mode, is switched off in case of no load or very low load, and switches on every two seconds for a short period. If the output current exceeds a set level, the inverter will continue to operate. If not, the inverter will shut down again.

The Search Mode can be set with a DIP switch.

The Search Mode "shut down" and "remain on" load levels can be set with VEConfigure.

The standard settings are:

Shut down: 40 Watt (linear load)

Turn on: 100 Watt (linear load)

AES (Automatic Economy Switch)

Instead of the search mode, the AES can also be chosen (with help of VEConfigure only).

If this setting is turned 'on', the power consumption in no-load operation and with low loads is decreased by approx. 20%, by slightly 'narrowing' the sinusoidal voltage. Not adjustable with DIP switches. Applicable in stand-alone configuration only.

Ground relay (see appendix B)

With this relay (H), the neutral conductor of the AC output is grounded to the chassis when the back-feed safety relay is open. This ensures the correct operation of earth leakage circuit breakers in the output.

If a non-grounded output is required during inverter operation, this function must be turned off. (See also Section 4.5)

Not adjustable with DIP switches.

Battery charge curve

The standard setting is 'Four-stage adaptive with BatterySafe mode'. See Section 2 for a description.

This is the recommended charge curve. See the help files in the software configuration programs for other features.

Battery type

The standard setting is the most suitable for Victron Gel Deep Discharge, Gel Exide A200, and tubular plate stationary batteries (OPzS). This setting can also be used for many other batteries: e.g. Victron AGM Deep Discharge and other AGM batteries, and many types of flat-plate open batteries. Four charging voltages can be set with DIP switches.

Automatic equalisation charging

This setting is intended for tubular plate traction batteries. During absorption the voltage limit increases to 2,83V/cell (34V for a 24V battery) once the charge current has tapered down to less than 10% of the set maximum current.

Not adjustable with DIP switches.

See 'tubular plate traction battery charge curve' in VEConfigure.

Absorption time

The absorption time depends on the bulk time (adaptive charge curve), so that the battery is optimally charged. If the 'fixed' charging characteristic is selected, the absorption time is fixed. For most batteries, a maximum absorption time of eight hours is suitable. If an extra high absorption voltage is selected for rapid charging (only possible for open, flooded batteries!), four hours is preferable. With DIP switches, a time of eight or four hours can be set. For the adaptive charge curve, this determines the maximum absorption time.

Storage voltage, Repeated Absorption Time, Absorption Repeat Interval

See Section 2. Not adjustable with DIP switches.

Bulk Protection

When this setting is 'on', the bulk charging time is limited to 10 hours. A longer charging time could indicate a system error (e.g. a battery cell short-circuit). Not adjustable with DIP switches.

AC input current limit

These are the current limit settings at which PowerControl and PowerAssist come into operation. The factory setting is **30A**.

See Section 2, the book 'Energy Unlimited', or the many descriptions of this unique feature on our website www.victronenergy.com.

Remark: lowest allowable current setting for PowerAssist: 8,5A*.

(8,5A per unit in case of parallel operation)

* Applies only when PowerAssist is enabled

UPS feature

If this setting is 'on' and AC on the input fails, the MultiPlus switches to inverter operation practically without interruption. The MultiPlus can therefore be used as an Uninterruptible Power Supply (UPS) for sensitive equipment such as computers or communication systems. The output voltage of some small generator sets is too unstable and distorted for using this setting* – the MultiPlus would continually switch to inverter operation. For this reason, the setting can be turned off. The MultiPlus will then respond less quickly to AC input voltage deviations. The switchover time to inverter operation is consequently slightly longer, but most equipment (most computers, clocks or household equipment) is not adversely impacted. Recommendation: Turn the UPS feature off if the MultiPlus fails to synchronise, or continually switches back to inverter operation.

*In general, the UPS setting can be left 'on' if the MultiPlus is connected to a generator with a 'synchronous AVR regulated alternator'.

The UPS mode may have to be set to 'off' if the MultiPlus is connected to a generator with a 'synchronous capacitor regulated alternator' or an asynchronous alternator.

Dynamic current limiter

Intended for generators, the AC voltage being generated by means of a static inverter (so-called 'inverter' generators). In these generators, rpm is down-controlled if the load is low: this reduces noise, fuel consumption and pollution. A disadvantage is that the output voltage will drop severely or even completely fail in the event of a sudden load increase. More load can only be supplied after the engine is up to speed.

If this setting is 'on', the MultiPlus will start supplying extra power at a low generator output level and gradually allow the generator to supply more, until the set current limit is reached. This allows the generator engine to get up to speed.

This setting is also often used for 'classic' generators that respond slowly to sudden load variation.

WeakAC

Strong distortion of the input voltage can result in the charger hardly operating or not operating at all. If WeakAC is set, the charger will also accept a strongly distorted voltage, at the cost of greater distortion of the input current.

Recommendation: Turn WeakAC on if the charger is hardly charging or not charging at all (which is quite rare!). Also turn on the dynamic current limiter simultaneously and reduce the maximum charging current to prevent overloading the generator if necessary.

Not adjustable with DIP switches.

BoostFactor

Change this setting only after consulting with Victron Energy or with an engineer trained by Victron Energy!

Not adjustable with DIP switches.

Programmable relay

By default, the programmable relay is set as an alarm relay, i.e. the relay will de-energise in the event of an alarm or a pre-alarm (inverter almost too hot, ripple on the input almost too high, battery voltage almost too low).

Not adjustable with DIP switches.

Near the connection terminals an LED illuminates when the relay is activated (refer to S, see appendix A).

VEConfigure software

With VEConfigure software the relay can also be programmed for other purposes, for example to provide a generator starting signal.

With VEConfigure, several other special application modes of operation can be programmed.

Example: A house or an office connected to the public mains, fitted with solar panels with energy storage in batteries.

The batteries are used to prevent return delivery to the mains. During the day, redundant solar energy is stored in batteries. This energy is used in the evenings and at night. An energy shortfall is compensated by the mains. The MultiPlus converts the battery DC voltage to AC. The power is always less than or equal to the power consumption, so that return delivery to the mains does not occur. In the event of mains failure, the MultiPlus isolates the premises from the mains, which become autonomous (self-sufficient). In this way, a solar energy installation or a combined micro-scale heating and power plant can be economically used in areas with an unreliable mains supply and/or financially unfavourable energy-return conditions.

5.3 Configuration by computer

All settings can be changed by means of a computer or with a VE.Net panel (except for the multi-functional relay and the VirtualSwitch when using VE.Net).

Some settings can be changed with DIP switches (see Section 5.2).

For changing settings with the computer, the following is required:

- VEConfigure3 software: can be downloaded free of charge at www.victronenergy.com.
- A MK3-USB (VE.Bus to USB) interface.
Alternatively, the Interface MK2.2b (VE.Bus to RS232) can be used (RJ45 UTP cable needed).

5.3.1 VE.Bus Quick Configure Setup

VE.Bus Quick Configure Setup is a software program with which systems with a maximum of three MultiPlus units (parallel or three phase operation) can be configured in a simple manner.

The software can be downloaded free of charge at www.victronenergy.com.

5.3.2 VE.Bus System Configurator

For configuring advanced applications and/or systems with four or more MultiPlus units, **VE.Bus System Configurator** software must be used. The software can be downloaded free of charge at www.victronenergy.com.

5.4 Configuration with a VE.Net panel

To this end, a VE.Net panel and the VE.Net to VE.Bus converter are required.

With VE.Net all parameters are accessible, with the exception of the programmable relay and some other advanced settings.

5.5 Configuration with DIP switches

Some settings can be changed with DIP switches

Procedure:

- a) Turn the Compact on, preferably without load and without AC voltage on the inputs. The Compact will then operate in inverter mode.
- b) Set the dipswitches as required.
- c) Store the settings by moving Dip switch 8 to "on" and back to "off".

5.5.1. DIP switch 1 and 2

Default setting: to operate the product with the "On/Off/Charger Only" switch

ds 1: "off"

ds 2: "on"

The default setting is required when using the "On/Off/Charger Only" switch in the front panel.

This setting should also be used in setups with a GX device or VE.Bus Smart dongle when no additional Digital Multi Control panel or VE.Bus BMS is connected.

When a Digital Multi Control panel or a VE.Bus BMS is included please refer to the settings below.

Setting for remote operation with a Multi Control Panel or a VE.Bus BMS:

ds 1: "on"

ds 2: "off"

This setting is required when a Multi Control Panel and/or a VE.Bus BMS is connected.

The Multi Control panel must be connected to one of the two RJ48 sockets B, see appendix A.

Setting for remote operation with a 3-way switch:

ds 1: "off"

ds 2: "off"

This setting is required when a 3-way switch is connected.

The 3-way switch must be wired to terminal L, see appendix A.

Only one remote control can be connected, i.e. either a switch or a remote control panel.

In both cases the switch on the product itself should be "on".

5.5.2. DIP switch 3 to 7

These DIP switches can be used to set:

- Battery charge voltage and Absorption time
- Inverter frequency
- Search mode
- AC input current limit 30A or 50A

ds3-ds4: Setting charge voltages

ds3-ds4	Absorption voltage	Float voltage	Storage Voltage	Absorption Time (hours)	Suitable for
dS3=off dS4=off (default)	14.4 28.8 57.6	13.8 27.6 55.2	13.2 26.4 52.8	8	Gel Victron Deep Discharge Gel Exide A200 AGM Victron Deep Discharge
dS3=on dS4=off	14.1 28.2 56.4	13.8 27.6 55.2	13.2 26.4 52.8	8	Gel Victron Long Life (OPzV) Gel Exide A600 (OPzV) Gel MK battery
dS3=off dS4=on	14.7 29.4 58.8	13.8 27.6 55.2	13.2 26.4 52.8	5	AGM Victron Deep Discharge Tubular plate or OPzS batteries in semi-float mode AGM spiral cell
dS3=on dS4=on	15.0 30.0 60.0	13.8 27.6 55.2	13.2 26.4 52.8	6	Tubular plate or OPzS batteries in cyclic mode

Batteries with high antimony content can typically be charged with a lower absorption voltage than batteries with low antimony content. (Please refer to our book "Electricity on Board" downloadable from our website www.victronenergy.com for details and suggestions about charging batteries). Contact your battery supplier for the correct charge voltages and change (with VE-configure) the voltage settings if required.

The default charge current setting is 75% of the maximum charge current. This current will be too high for most applications.

For most battery types the optimal charge current is 0.1-0.2x the battery capacity.

ds5: Inverter frequency off = 60Hz on = 50Hz

ds6: Search Mode off = off on = on

ds7: AC input current limit off = 30 Amp on = 50 Amp

Store the settings by moving Dip switch 8 to "on" and back to "off".

5.5.3 Exemplary settings

Example 1 is the factory setting

ds-1 ds-2 Panel option ds-3 Ch. voltage ds-4 Ch. voltage ds-5 Frequency ds-6 Search mode ds-7 AC-in Limit ds-8 Store setting		ds-1 ds-2 ds-3 ds-4 ds-5 ds-6 ds-7 ds-8		ds-1 ds-2 ds-3 ds-4 ds-5 ds-6 ds-7 ds-8	
Example 1: (factory setting) 1 No panel or remote switch connected 2 No panel or remote switch connected 3, 4 GEL 14.4 V 5 Frequency: 60Hz 6 Search mode off 7 AC-in Limit 30 Amp 8 store setting: off→ on→ off	Example 2 1. No panel or remote switch connected 2. No panel or remote switch connected 3,4. AGM 14,7V 5. Frequency: 60Hz 6. Search mode off 7. AC-in Limit 50 Amp 8. store setting: off→ on→ off	Example 3 1. Panel or remote switch connected 2. Panel or remote switch connected 3, 4. Tubular plate 15V 5. Frequency: 50Hz 6. Search mode on 7. AC-in Limit 30Amp 8. store setting: off→ on→ off			

Store the settings (ds-3 to ds-7) by changing switch ds-8 from 'off' to 'on', and then back to 'off'.

The LED's 'charger' and 'alarm' will flash to indicate acceptance of the settings.

6 Maintenance

The Compact does not require specific maintenance. It will suffice to check all connections once a year. Avoid moisture and oil/soot/vapours, and keep the device clean.

7. TROUBLE SHOOTING TABLE

Proceed as follows for quick detection of common faults.

DC loads must be disconnected from the batteries and the AC loads must be disconnected from the inverter before the inverter and/ or battery charger is tested.

Consult your Victron Energy dealer if the fault cannot be resolved.

Problem	Cause	Solution
The inverter fails to operate when switched on.	The battery voltage is too high or too low.	Ensure that the battery voltage is within the correct value.
The inverter fails to operate	Processor in no function-mode.	Disconnect mains voltage. Switch Front switch off, wait 4 seconds Switch front switch on.
The alarm LED flashes.	Pre-alarm alt. 1. The DC input voltage is low.	Charge the battery or check the battery connections.
The alarm LED flashes	Pre-alarm alt. 2. The ambient temperature is too high.	Place the inverter in a cool and well-ventilated room, or reduce the load.
The alarm LED flashes.	Pre-alarm alt. 3. The load on the inverter is higher than the nominal load.	Reduce the load.
The alarm LED flashes.	Pre-alarm alt. 4. Voltage ripple on the DC input exceeds 1.25Vrms.	Check the battery cables and terminals. Check the battery capacity; increase if necessary.
The alarm LED flashes intermittantly.	Pre-alarm alt. 5. Low battery voltage and excessive load.	Charge the batteries, reduce the load or install batteries with a higher capacity. Use shorter and/or thicker battery cables.
The alarm LED is on	The inverter did cut out following a pre-alarm.	Check the table for the appropriate course of action.

Problem	Cause	Solution
The charger is not functioning	The AC input voltage or frequency is out of range.	Ensure that the input voltage is between 95 Vac and 140 Vac, and that the frequency matches the setting.
The battery is not being charged fully.	Incorrect charging current.	Set the charging current at between 0.1 and 0.2x battery capacity.
	A defective battery connection.	Check the battery terminals.
	The absorption voltage has been set to an incorrect value.	Adjust the absorption voltage to the correct value.
	The float voltage has been set to an incorrect value.	Adjust the float voltage to the correct value.
	The internal DC fuse is defective.	Inverter is damaged.
The battery is overcharged.	The absorption voltage has been set to an incorrect value.	Adjust the absorption voltage to the correct value.
	The float voltage has been set to an incorrect value.	Adjust the float voltage to the correct value.
	A defective battery.	Replace the battery.
	The battery is too small.	Reduce the charging current or use a battery with a higher capacity.
	The battery is too hot.	Connect a temperature sensor.
Battery charge current drops to 0 when the absorption voltage is reached	Alt. 1: Battery overtemperature (> 50°C)	- Allow battery to cool down - Place battery in a cool environment - Check for shorted cells
	Alt 2: Battery temperature sensor faulty	Unplug battery temperature sensor from the Multi. Reset the Multi by switching it off, then wait for 4 seconds and switch it on again If the Multi now charges normally, the battery temperature sensor is faulty and needs to be replaced

8. TECHNICAL DATA

MultiPlus	12/2000/80-50 120V	24/2000/50-50 120V
PowerControl / PowerAssist	Yes	
Transfer switch (A)	50	
Minimum PowerAssist current (A)	8,5	8,0
INVERTER		
Input voltage range (V DC)	9,5 – 17	19 – 33
Output	Output voltage: 120 VAC ± 2% Frequency: 60 Hz ± 0,1% (1)	
Cont. output power at 25°C (VA) (3)	2000	
Cont. output power at 25°C (W)	1600	
Cont. output power at 40°C (W)	1450	
Peak power (W)	4000	
Maximum efficiency (%)	92	94
Zero-load power (W)	9	11
Zero load power in search mode (W)	3	4
CHARGER		
AC Input	Input voltage range: 95-140 VAC Input frequency: 45 – 65 Hz Power factor: 1	
Charge voltage 'absorption' (V DC)	14,4 / 28,8	28,8
Charge voltage 'float' (V DC)	13,8 / 27,6	27,6
Storage mode (V DC)	13,2 / 26,4	26,4
Charge current house battery (A) (4)	80	50
Charge current starter battery (A)	4	
Battery temperature sensor	yes	
GENERAL		
Programmable relay (5)	yes	
Protection (2)	a - g	
Common Characteristics	Operating temp. range: -40 - +40°C (fan assisted cooling) Humidity (non condensing) : max 95%	
ENCLOSURE		
Common Characteristics	Material & Colour: aluminium (blue RAL 5012) Protection category: IP20	
Battery-connection	Bolts M8	
120 V AC-connection	screw-terminals 6 AWG (13mm ²)	
Weight (lbs)	25 (13 kg)	
Dimensions (hwxwd in inches)	20.5 x 10.0 x 5.0 (520 x 255 x 125 mm)	
STANDARDS		
Safety	EN 60335-1, EN 60335-2-29, UL 458	
Emission / Immunity	EN 55014-1, EN 55014-2, EN 61000-3-3	

- 1) Can be adjusted to 50Hz
- 2) Protection
 - a. Output short circuit
 - b. Overload
 - c. Battery voltage too high
 - d. Battery voltage too low
 - e. Temperature too high
 - f. 120VAC on inverter output
 - g. Input voltage ripple too high
- 3) Non linear load, crest factor 3:1
- 4) At 25 °C ambient
- 5) Programmable relay which can be set for general alarm, DC undervoltage or genset start signal function

APPENDIX A: Connection overview

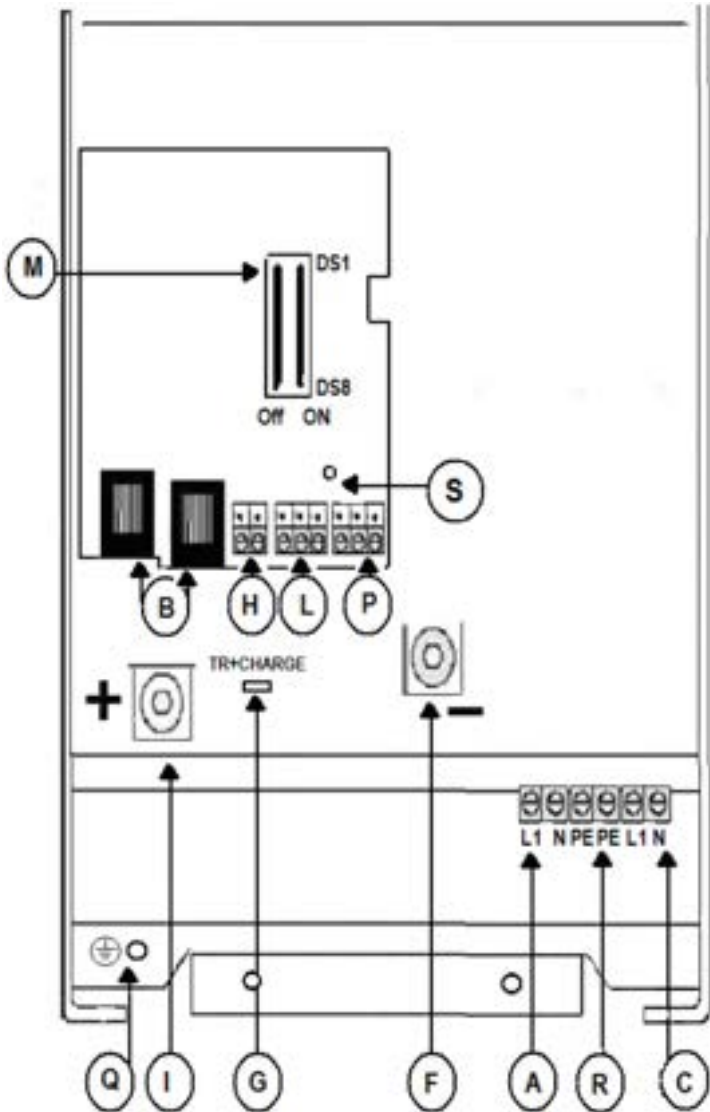

APPENDIX A: Connection overview

A	AC input line L1 and neutral (N)
B	2x RJ45 connector for remote panel and/or parallel and 3-phase operation.
C	AC output line L1 and neutral (N).
F	M8 battery minus connection.
G	Starter battery positive (TR CHARGE). (<i>starter battery minus: use battery minus cable for connection</i>).
H	Terminals for (left to right): temperature sensor positive, temperature sensor minus.
I	M8 battery positive connection.
L	Connector for remote switch: Short right and middle terminal to switch "on". Short left and middle terminal to switch to "charger only".
M	DIP switches for set-up mode.
P	Terminals for (left to right): Multi-functional relay NO - COM - NC
Q	Cabinet GND terminal
R	PE (ground) terminals
S	Indicator Programmable relay LED illuminates when relay is activated

APPENDIX B Installation information

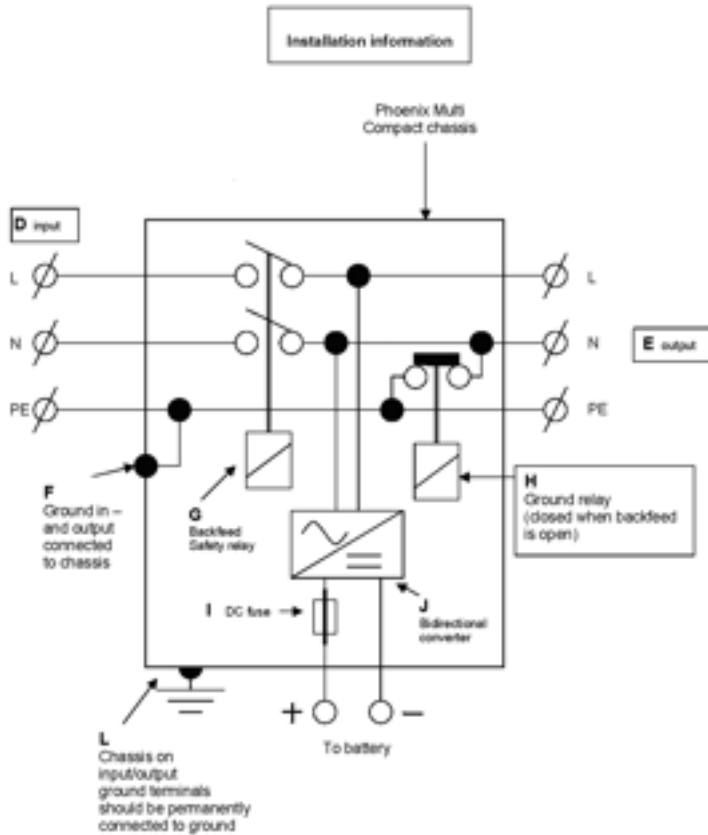

APPENDIX C: Parallel connection

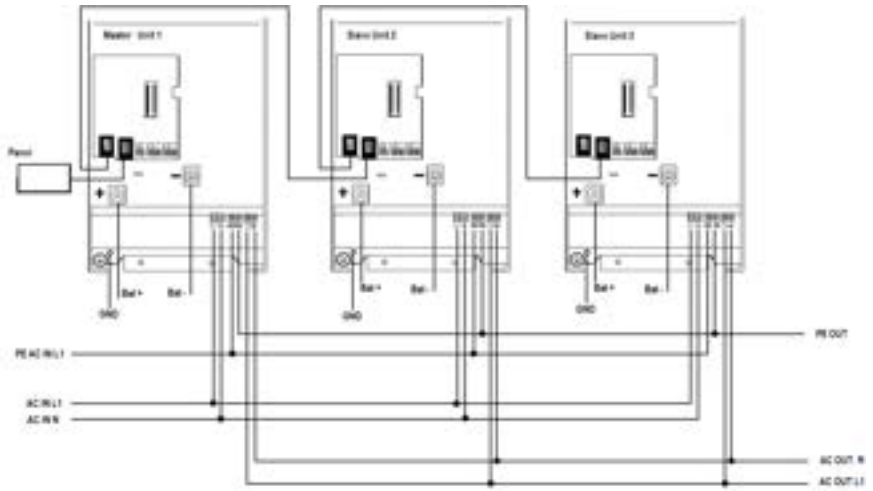

APPENDIX D: Three-phase connection

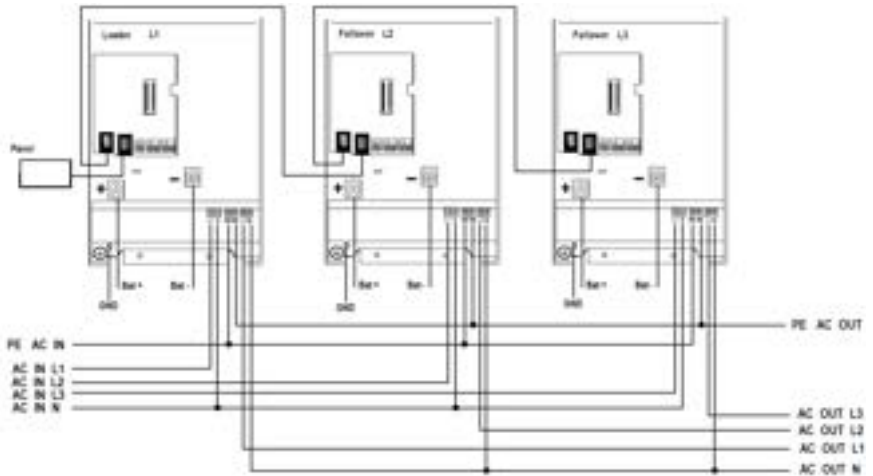

APPENDIX E: split phase connection

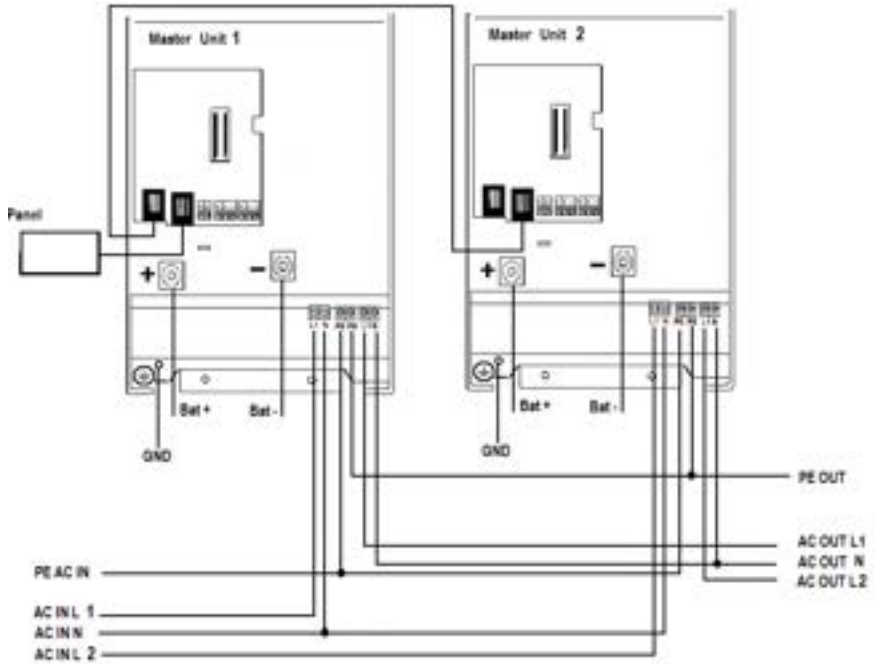

APPENDIX F: Charge curve

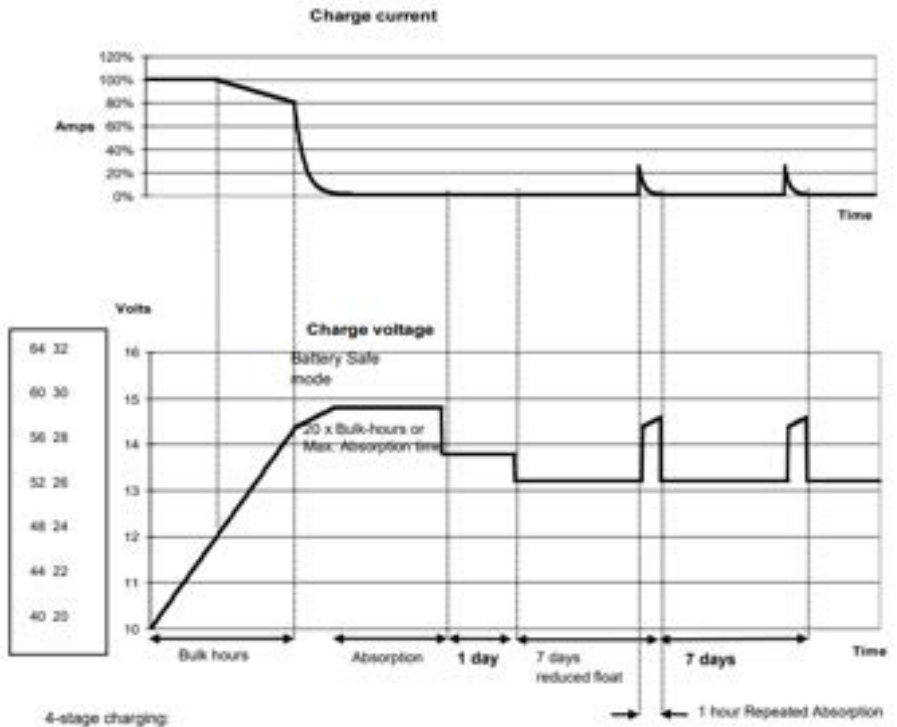

Bulk-mode: Entered when charger is started. Constant current is applied until the gassing voltage is reached (14.4V resp. 28.8V, temperature compensated).

Battery Safe Mode: If, in order to quickly charge a battery, a high charge current in combination with a high absorption voltage has been chosen, the Multi Compact / MultiPlus Compact will prevent damage due to excessive gassing by automatically limiting the rate of voltage increase once the gassing voltage has been reached. The Battery Safe Mode is part of the calculated absorption time.

Absorption-mode: A constant voltage period to fully charge the battery. The absorption time is equal to 20x bulk time or the set maximum absorption time, whichever comes first.

Float-mode: Float voltage is applied to keep the battery fully charged and to protect it against self-discharge. Reduced Float: After one day of Float charge a reduced Float charge is applied. This is 13,2V resp. 26,4V (for 12V and 24V charger). This will limit water loss to a minimum when the battery is stored for the winter season. After an adjustable time (default = 7 days) the charger will enter Repeated Absorption-mode for an adjustable time (default = 1 hour).

APPENDIX G: Temperature compensation

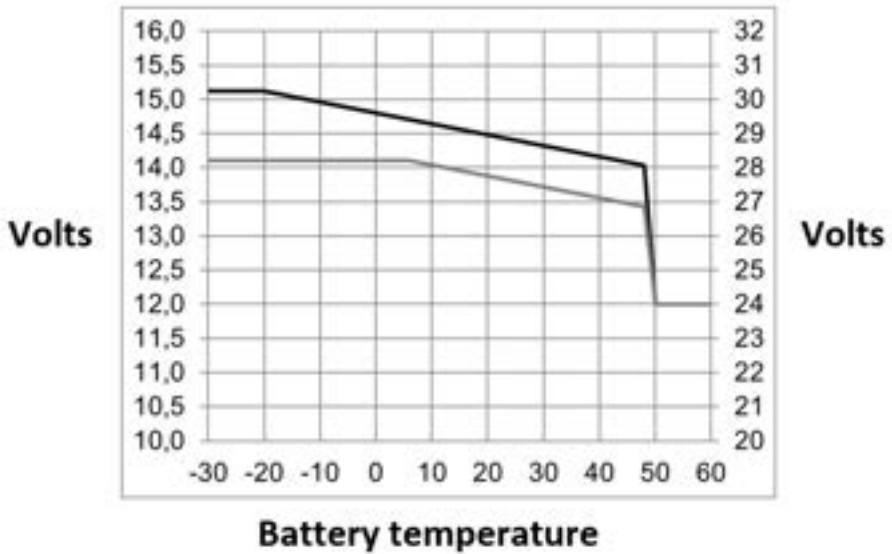

Default output voltages for Float and Absorption are at 25°C.

Reduced Float voltage follows Float voltage and Raised Absorption voltage follows Absorption voltage.

In adjust mode temperature compensation does not apply.

Dimensions
Afmetingen
Dimensions
Abmessungen

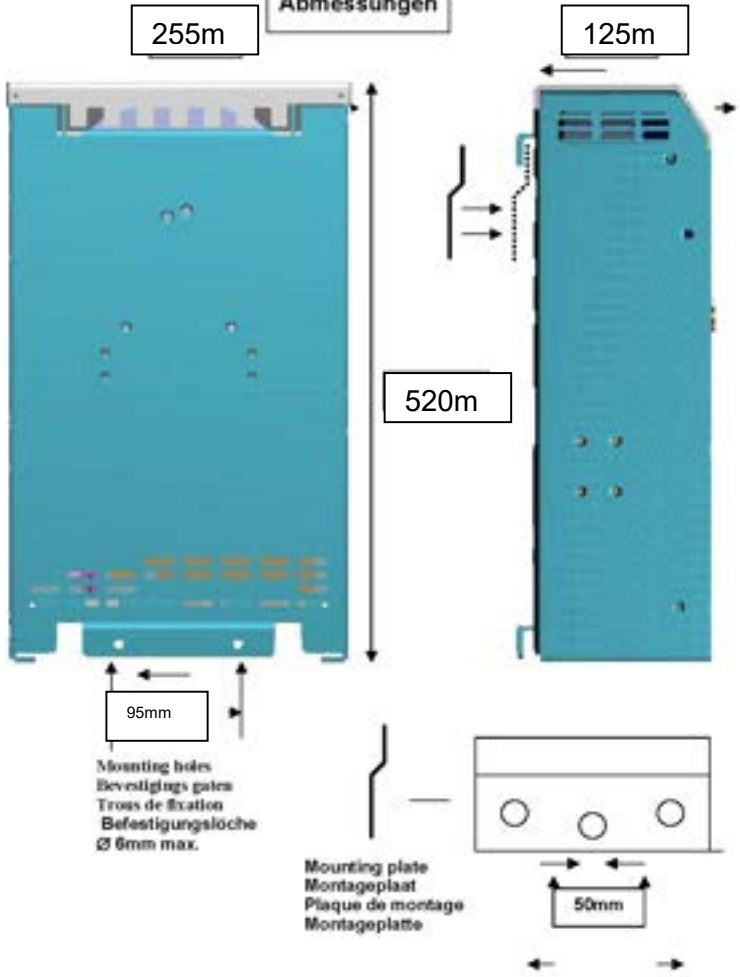

Victron Energy Blue Power

Distributor:

Serial number:

Version : 09

Date : June 1st, 2022

Victron Energy B.V.
De Paal 35 | 1351 JG Almere
PO Box 50016 | 1305 AA Almere | The Netherlands

E-mail : sales@victronenergy.com

www.victronenergy.com