



# Ventura 150/200T

## Installation and Operating Manual



Spectra Watermakers  
Katadyn Desalination LLC.  
2220 S. McDowell Blvd. Ext. Petaluma, CA 94954  
Phone: 415-526-2780 Fax: 415-526-2787  
techsupport@spectrawatermakers.com  
www.spectrawatermakers.com  
Updated March 2020





## Table of Contents

Getting Started .....	5
<b>Installation</b> .....	7
Introduction.....	9
Installation Basics .....	10
Ventura Plumbing.....	11
Product Water and Pressure Gauge Tube Installation.....	12
Parker Tube Fitting Assembly Procedure .....	13
John Guest Tube Fitting Assembly Procedure.....	14
Spectra High Pressure Fitting Instructions .....	15
Wiring .....	16
Optional Z-Ion Installation and Instructions .....	17
<b>Operation</b> .....	23
New Systems Start Up Procedure .....	24
Normal Operation and Fresh Water Flush .....	25
Dry Testing with an Artificial Ocean .....	26
Optimizing the Fresh Water Flush Duration .....	27
<b>Maintenance, Storage, and Troubleshooting</b> .....	29
Suggested Spares .....	30
Maintenance .....	31
Introduction to Spectra Chemicals.....	33
Storage Procedure.....	35
Winterizing with Propylene Glycol.....	36
Membrane Cleaning Procedure .....	37
Ventura Flow Test .....	38
Troubleshooting .....	41
Technical Bulletins.....	43
Parts Identification .....	49



# Getting Started

Unpack the system and inspect it for damage during shipping. Freight damage must be reported within 24 hours.

Refer to the shipping list for your system to ensure you received all of the components listed. Do not discard any packaging until you have found and identified all of the parts. The small installation parts are listed on the kit list.

***Warning! We will not be held responsible for shortages that are not reported within thirty days of the ship date.***

Study the system layout diagram, component photos, and descriptions before beginning installation.

Lay out the system. Before starting the installation identify where each module and component will be placed. Ensure that there is enough clearance around the components for removal of filters and system service. Make sure you have adequate tubing and hose before starting. Additional parts may be ordered.

*THE VENTURA 200T IS DESIGNED FOR WARM WATER USE. OPERATION IN WATERS BELOW 50° F (10° C) MAY CAUSE HIGH OPERATING PRESSURES AND INCREASED WEAR ON THE FEED PUMP*

## Ventura Shipping List

- High Pressure Clark Pump and Reverse Osmosis Membrane Module
- Inlet Feed Pump Module with Fresh Water Flush System
- Accumulator Tank
- Manual
- Analog Gauge Assembly
- Installation Fittings Kit
- 5/8" Hose (2 x 25')
- Service Kit



# Installation





# Introduction to the Ventura

The Ventura is the finest watermaker for small and mid-sized yachts. Properly installed and maintained it will provide years of reliable service. Prudent operation is required with any marine equipment. ***Always maintain enough reserve water to get safely into your next port.***

The Spectra Intensifier, known as the Clark Pump, was introduced in 1997 and has been continually improved since. It is built of modern non-corrosive composites and comes with a 20" high rejection membrane.

## Front View



The Clark Pump Membrane Module. Pre-mounted and plumbed together as a single unit. Saves time and adds reliability.



## Ventura Feed Pump Module

Includes the feed pump, cooling fan, charcoal filter, flush valve, service valve, and service port. The module has compact and streamlined plumbing. The cooling fan is included for longevity.

## Installation Basics

- **Read the directions!**
- Avoid tight hose bends and excessive runs.
- Use heavy gauge wire.
- Install feed pump module as low as possible.
- Use a dedicated thru-hull with scoop type strainer.
- Do not mount components over electrical devices.
- **Avoid getting dirt or debris into the piping or hoses during assembly.** A small bit of debris can stop the system!

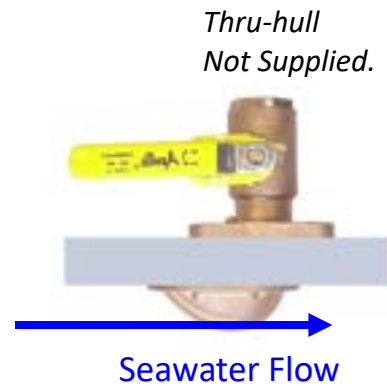

**Thru-hull Location:** The system must be connected to a dedicated 1/2" to 3/4" forward facing scoop-type intake thru-hull and seacock.

Install the thru-hull intake as far below the waterline and as close to centerline as possible to prevent air or contamination from entering the system. Do not install the intake close to, or downstream of a head discharge, keel, stabilizer fins, or other underwater fixtures.

Thru-hulls near the bow are susceptible to air intake in rough conditions. Sharing a thru-hull can cause flow restrictions, intake of air bubbles or contaminants, and will void the warranty. For racing boats and high speed boats traveling above 15 knots, a retractable, snorkel-type thru-hull fitting is preferred because it picks up water away from the hull.

**The brine discharge thru-hull** should be above the waterline, along or just above the boot stripe, to minimize water lift and back pressure.

Double clamp all hose connections below the waterline.

Avoid restrictions or long hose runs along the intake plumbing, from the thru-hull to the feed pump module.

Secure the piping away from moving objects such as engine belts and hatches. Prevent chafe on the tubing as required. After several hours of operation, inspect all piping and hose clamps for leaks.

**Pipe Fitting Instructions:** To seal plastic-to-plastic fittings, wrap 6 to 8 layers of Teflon tape around the threads. Hold the fitting in your left hand and tightly wrap the threads clockwise. For smoother assembly, do not tape the first (starting) threads.

### Wiring

- Pay attention to wire size or system performance will be impaired
- Perform wiring to UL, ABYC, CE or applicable standards

# Ventura Plumbing



**Brine discharge thru hull (not included):** place above waterline or tee into another visible drain.

Note: Brine discharge may be connected to either side of Clark Pump



**Spectra Clark Pump and Pressure Vessel/Membrane:** Mount in a cool location (below 120 deg. F/49 deg. C). May be oriented in any position and can be well above waterline. Leave access to the pressure relief valve. Do not mount over electrical equipment. Use supplied spacers and washers for the vibration mounts.



**Accumulator:**  
Factory pre-charged



**5 micron filter:**  
Do not mount over electrical equipment. Leave clearance below for filter changes.

Use the supplied 5/8-inch (15.9mm) clear braided vinyl hose for all runs. More hose may be ordered from Spectra, or bought at a hardware or marine store.

**Fresh Water Flush inlet to charcoal filter:**  
Plumb to the pressurized side fresh water system.



**Feed Pump Module:** Mount vertically as low as practical, no more than 3' (1M) above waterline and not over electrical equipment. Leave clearance below for filter changes.

**Sea Strainer:** Mount with included Quick Block



**1/2" or 3/4 scoop strainer thru-hull and Seacock:** Mount low, in a clear flow and away from head discharge.



# Product Water Plumbing and Pressure Gauge Tube Installation

Sampling Tap for testing the product water.

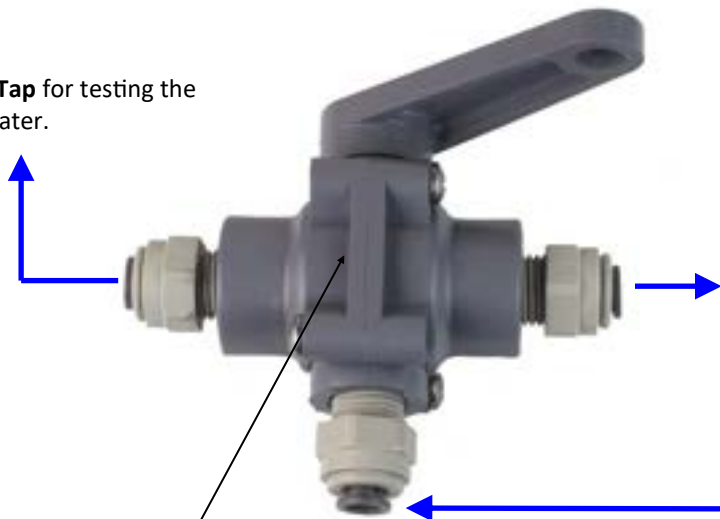

**Product to tank:** Route the product water from the valve into the top of a vented tank. Install a tee in the water fill or tap a pipe thread into an inspection port.

**DO NOT!** feed the product into a vent line, manifold, or the bottom of the tank. Make sure that there is no restriction in this piping. **Pressure in the product tubing must never exceed 5psi (.3bar)**, running or stopped, or the membrane will be permanently damaged.

**Product Sampling Valve:** Mount using the supplied plastic straps. **Note: the handle points in the direction of flow.**



Use accumulator port to connect the pressure gauge with the supplied 1/4" black nylon tubing. Tubing must be pressure rated to 150 PSI (10 BAR).

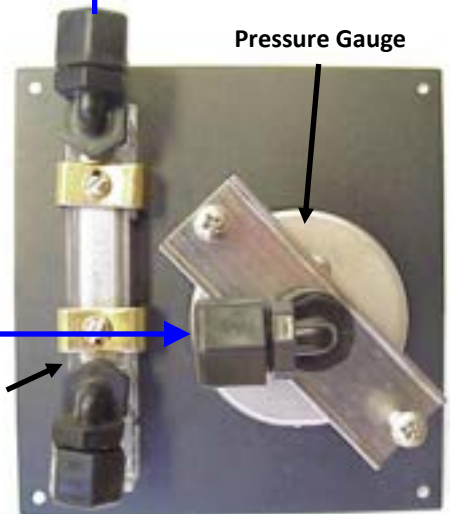

Pressure Gauge

Product Flow Meter

Back view of instrument panel

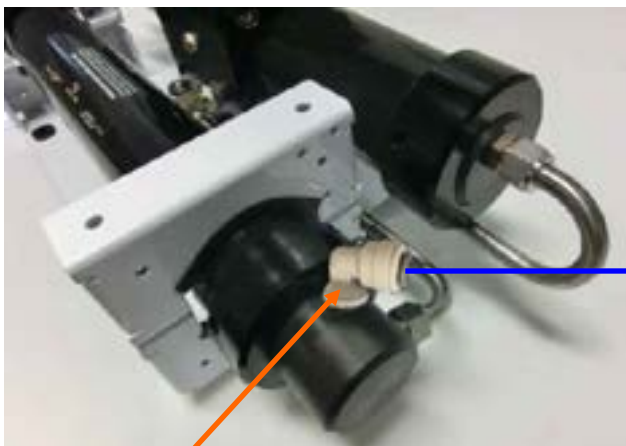

Product output fitting.

Use the supplied 1/4" black nylon tubing for the product plumbing.

# Parker Tube Fitting Assembly Procedure

## Fast & Tite® Thermoplastic Fittings

Fast & Tite® fittings are the most complete line of plastic fittings for thermoplastic tubing in the industry.

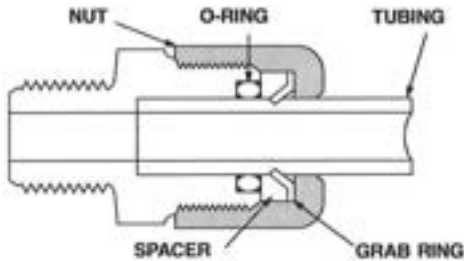

Fast & Tite® thermoplastic tube fittings from Parker will prove to be the answer to your tubing connector needs. Patented Fast & Tite® fittings install in seconds without tools and provide a tight, sure, leak proof seal without clamps or adjustments. A unique 302 stainless steel grab ring for tube retention, coupled with a Nitrile O-Ring for positive seal, assures good tube connection with only hand tight assembly. A plastic grab ring is also available upon special request. Vibration or tube movement will not break the seal and cause leakage. Preassembled in either highly inert polypropylene, or strong, durable nylon, Fast & Tite® fittings are the answer to full flow thermoplastic tubing system requirements.

When necessary, Fast & Tite® fittings can be disassembled by hand for fast system drainage. Fittings are completely reusable.

Parts are easily replaced. O-Rings are standard size and universally available. (For applications requiring other than Nitrile O-Rings, consult your Fast & Tite® distributor.)

Use Fast & Tite® fittings with Parker Parflex tubing or other plastic, glass or metal tubing for low pressure or vacuum lines up to the pressure limits shown below.

Fast & Tite® fittings meet FDA and NSF-51 requirements for food contact.

### Working Pressures for Fast & Tite® Fittings

Tube O. D., in.	Air-Oil-Water Pressure in PSI		
	Up to 75°F	76° to 125°F	126° to 175°F
1/4	300	300	300
5/16	300	300	300
3/8	250	250	150
1/2	200	200	150
5/8	150	100	50

Ratings are based on use with copper tubing, and in all cases represent the maximum recommended working pressure of the fitting only. Working pressures (vs. temperatures) of other types of tubing may limit the tube and fitting assembly to pressures lower than shown above. Consult factory for recommendations on applications other than shown above.

### Temperature Range:

Black/White Polypropylene: 0°F (-18°C) to +212°F (+100°C)

White Nylon: -40°F (-40°C) to +200°F (+93°C)

## Fast Assembly

### Step 1.



Cut the tube squarely and remove any burrs.

### Step 2.



Mark from end of tube the length of insertion. (See table below)

Tube O.D. (in.)	Insertion Length with Tube Support (in.)	Insertion Length without Tube Support (in.)
1/4	5/8	9/16
5/16	5/8	9/16
3/8	13/16	3/4
1/2	7/8	13/16
5/8	1	15/16

### Step 3.

Loosen nut on fitting until three threads are visible. Fittings for glass tubes must be disassembled and the grab ring removed.

### Step 4.

Moisten end of the tube with water. Push the tube **Straight** into fitting until it bottoms on the fitting's shoulder. Tighten nut by hand. Additional tightening should not be necessary, but 1/4 additional turn may be added if desired. **Do not overtighten** nut as the threads will strip and the fitting will not function properly. A proper assembly will not show the insertion mark extending beyond the nut. If the insertion mark is visible, then steps 1 thru 4 must be repeated.

### Step 5.

When using clear vinyl tubing or urethane tubing, it is necessary to use a **TS** tube support. Disassemble the fitting and place the nut, grab ring, spacer and tube support, in that order on the tube. Locate the grab ring at the insertion mark as shown. Seat the O-ring in the body, then proceed with Step 4.

**Note:** Provide adequate fail-safe mechanisms such as leakage detection sensors, automatic shut-off controls or other industry and code appropriate fail-safe devices in the design of your water-handling appliance to protect against personal injury and property damage.

Plastic fittings containing an o-ring that are used in water applications should be replaced at least every five years or more frequently depending on the environment and severity of the application.

# John Guest Super Speedfit Fittings

## How Super Speedfit Works

To make a connection, the tube is simply pushed in by hand; the unique patented John Guest collet locking system then holds the tube firmly in place without deforming it or restricting flow.

### Materials of construction

**Super Speedfit** fittings are made up of three components:

**Bodies** are produced in an acetal copolymer or polypropylene.

**'O' rings** are Nitrile rubber or EPDM.

**Collets** are produced in acetal copolymer or polypropylene with stainless steel teeth.

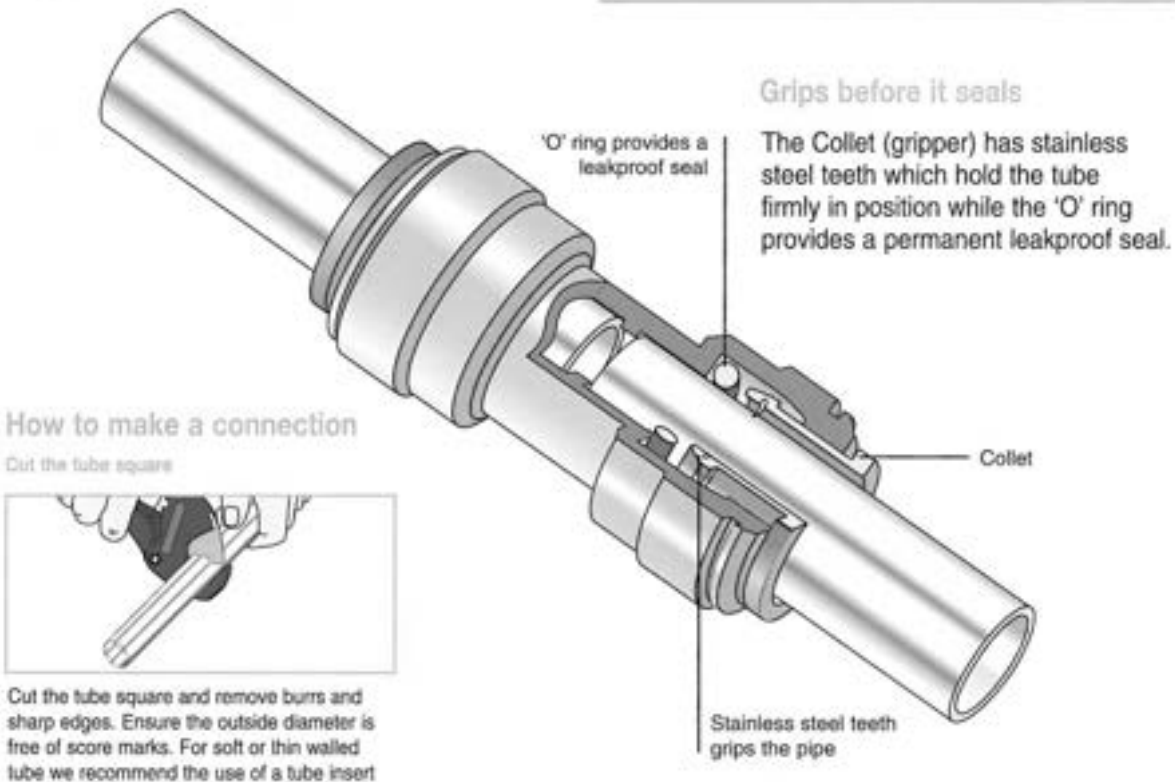

## How to make a connection

Cut the tube square



Cut the tube square and remove burrs and sharp edges. Ensure the outside diameter is free of score marks. For soft or thin walled tube we recommend the use of a tube insert

Push up to tube stop



Push the tube into the fitting, to the tube stop.

Pull to check secure



Pull on the tube to check it is secure. Test the system before use.

## To disconnect

Push in collet and remove tube

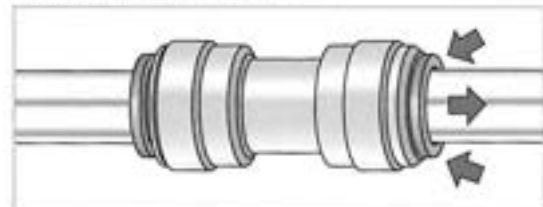

To disconnect, ensure the system is depressurized, push the collet square against the fitting. With the collet held in this position the tube can be removed.



# Spectra High Pressure Fitting Instructions

The Ventura has eight high pressure fittings, two on each cylinder on the Clark Pump, two on the pressure vessel end caps, and two 90-degree elbows on the back of the Clark Pump. As the compression fitting is tightened, it compresses a ferrule onto the stainless tubing, fixing the ferrule permanently to the tube and holding the compression nut captive.

The body of the fitting seals to the underlying component with an O-ring. On the Clark Pump cylinders and the end caps this O-ring is compressed by tightening the entire fitting. The O-rings on the 90-degree fittings on the back of the Clark Pump have captive nuts and washers, which compress the O-rings without turning the entire fitting.

If a tube fitting leaks it can sometimes be resealed by just tightening. You must use two wrenches, a 13/16-inch wrench to hold the base, and a 7/8-inch wrench to turn the compression nut. The 13/16-inch wrench will need to be thin so as not to interfere with the compression nut. If this doesn't work, disassemble the fitting, grease liberally with silicone grease (the ferrule and the threads) and re-tighten firmly.

The base O-rings should be **gently** compressed to achieve a good seal, and may be damaged by overtightening.

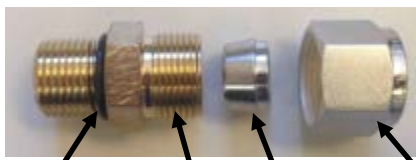

Connector O-RING

Ferrule

Stainless Fitting Hex Nut

Nickel-Bronze High Pressure Straight Fitting



Nickel-Bronze High Pressure Elbow

# Ventura Wiring

Route a pair of heavy wires from a properly-sized fuse or breaker on main DC electrical panel to the feed pump module. Refer to wire size guides below. **Wire length is the sum of the length of the Positive and Negative wires together.**

**Example:** 7 feet of duplex wire (two wires in a sheath) is needed to connect the DC electrical panel to the feed pump module. In order to figure out what type of wire you need:  $7 + 7 = 14$ . Since 14 is less than 15 you would use: #10 Gauge (6mm) to 15 feet (4.5 M).

Connect wires using supplied terminal block, then seal the connectors. The switch on the feed pump will facilitate maintenance. You may also wish to switch the system remotely, as from a switch or breaker on the main distribution panel. *Voltage drop will impair performance of the system.*

## Wire Size Guide for 12 VDC Ventura

Protect with 15 Amp fuse or circuit breaker

# 10 Gauge (6mm<sup>2</sup>) to 15 feet (4.5M)

# 8 Gauge (10mm<sup>2</sup>) to 25 feet (7.5M)

#6 Gauge (16mm<sup>2</sup>) to 35 feet (10.6M)

## Wire Size Guide for the 24 VDC Ventura

Protect with 7.5 Amp fuse or circuit breaker

#10 Gauge (6mm<sup>2</sup>) to 25 feet (7.6M)

#8 Gauge (10mm<sup>2</sup>) to 35 feet (10.6M)

### Feed Pump wiring:

Red is positive.

Black/Yellow is ground.

**Cooling Fan** connects in parallel with the feed pump. Pre-wired at the factory.

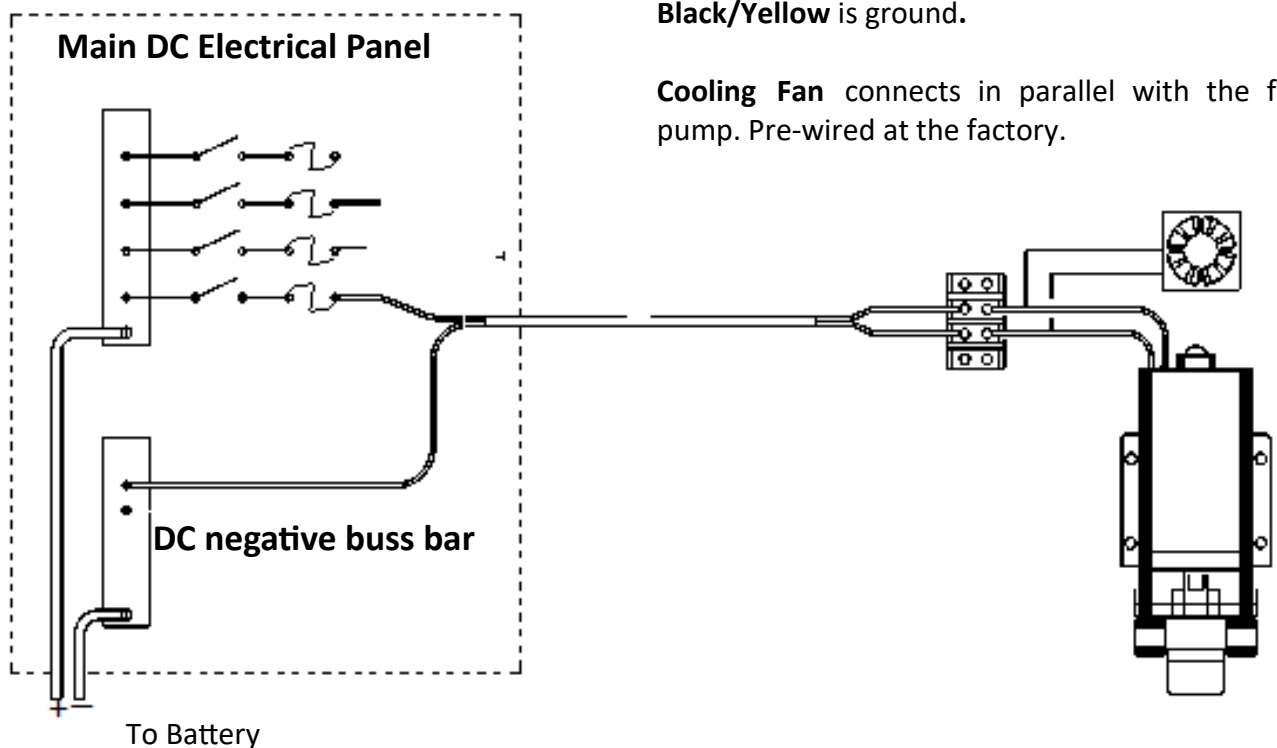



## **Optional Z-Ion Protection System**

The Z-Ion, developed by Spectra, protects the entire system from fouling for extended periods without fresh water flushing or storage chemicals (pickling).

The Z-Ion achieves this end by introducing a stream of metallic ions into the fresh water flush water, thus flooding the entire system with ions that prevent biological growth for up to thirty days. If you are going to let your system sit idle for longer than thirty days, you will still need to treat it with SC-1 storage chemical or propylene glycol.

The Z-Ion will not prevent freezing, so in freezing climates pickling with propylene glycol is still required. Even with the Z-Ion there may still be cases when you need to pickle your system with SC-1 storage chemical or propylene glycol, so we recommend you carry one of these products at all times.

If your system was ordered with the Z-Ion, it will require only some basic wiring and commissioning, laid out in the following pages.

If you didn't order your system with the Z-Ion, it can be retrofitted to any Spectra system.

# Z-Ion Installation

If you did not order your Ventura system with the optional Z-Ion you may disregard this section of the manual.

If you ordered your Ventura with a Z-Ion, the feed pump module will come with the Z-Ion installed in place of the standard fresh water flush module, as shown, with a separate Z-Ion electronic control box:

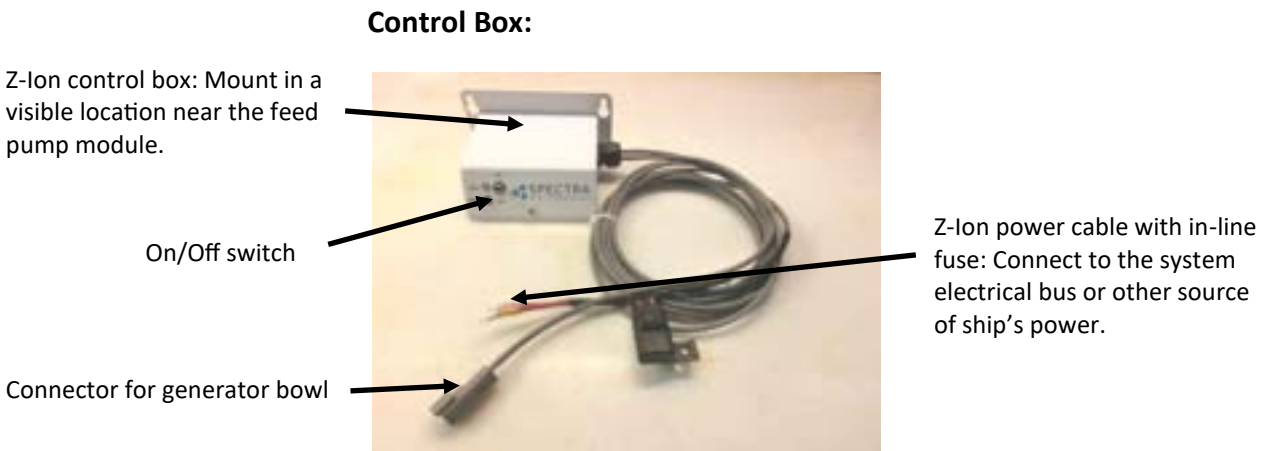
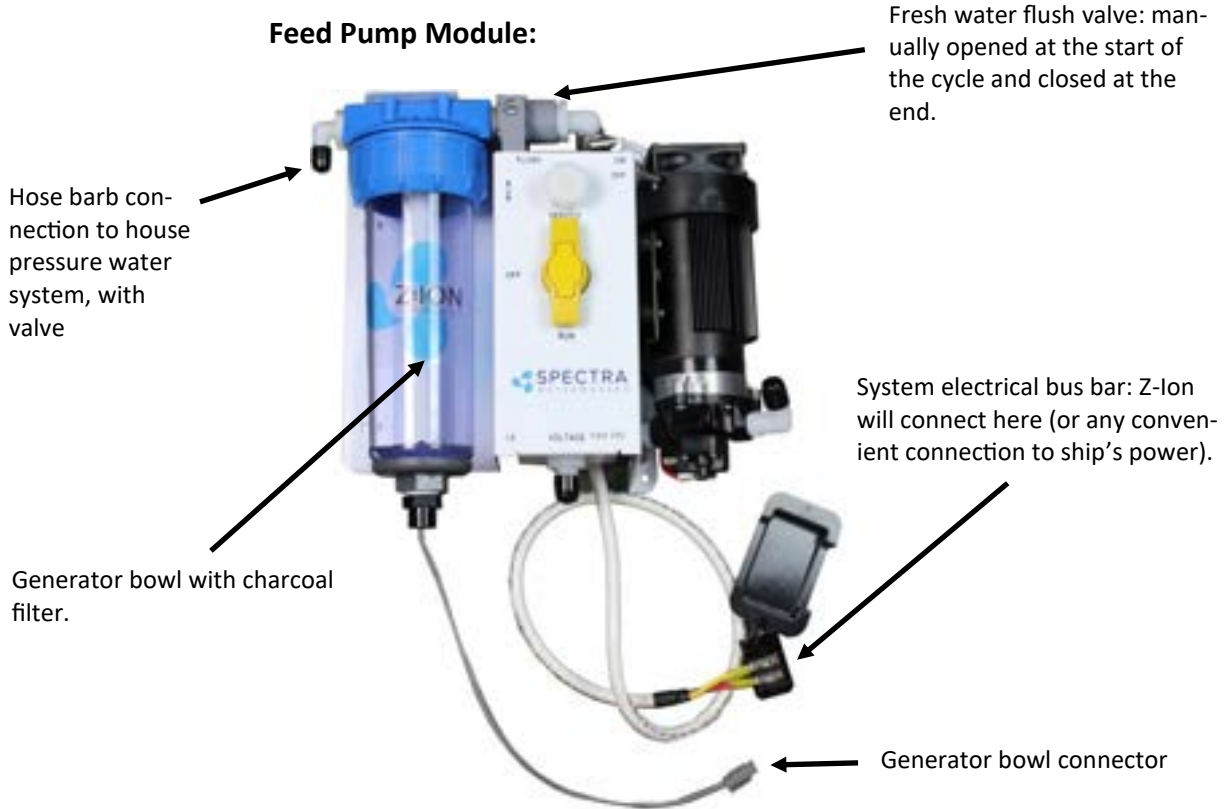

# Z-Ion Installation continued...

## Z-Ion Power Connections

Turn the main DC breaker off or remove the main power fuse to the watermaker.

Locate the DC Bus Bar for the watermaker (or any other DC power source), as shown below. Connect the DC power leads from the Z-Ion Control Box to the Incoming DC Bus Bar.

- Pay attention to polarity!
- Connect Red (fuse) to DC +
- Yellow (or black) to DC -
- Replace protective cover

**Z-Ion Fuse holder:** Install in a dry location with easy access.

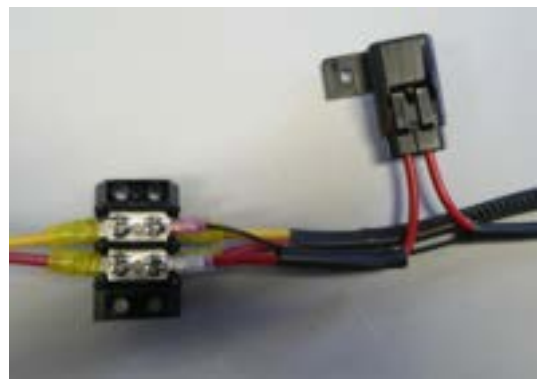

## Connection from generator bowl to control box:

The pigtail from the control box has a water-tight connector, which connects to the pigtail from the generator bowl:





## Z-Ion Operation

The Z-Ion should be energized at all times, but will only consume power when operating. Upon initial power-up the LED will flash red/green and then will turn solid green.

Follow the instructions for Normal Operation and Fresh Water Flush. For treatment with the Z-Ion, the process is identical, only the Z-Ion will release silver and copper ions into the flush water when you turn on the generator with the on/off switch. Turn on the ion generator at the same time that you open the flush valve.

The operation cycle begins and the LED will flash green/amber. The cycle will continue until you turn off the ion generator or adjustable timer times out (factory set for 15 minutes).

Turn off the ion generator at same time that you close the flush valve. If you forget to turn off the ion generator, the Z-Ion will time out after 15 minutes, so no harm will be done to the unit.

If the voltage is out of range, below 10V or above 56V, the LED will flash red every two seconds and the unit will shut down.

Each fresh water flush with the Z-Ion will protect your watermaker for up to 30 days, after which the process must be repeated.

After 720 cycles the service light on the front of the control box will light up, indicating that the probes on your Z-Ion may be wearing down, and should be tested. The service light is just a reminder, and the Z-Ion will go on functioning while it is lit. For testing procedures, see the next page.

To reset the service counter, touch two magnets, at the same time, to the two red reed switches on the Z-Ion circuit board, labeled Switch 1 and Switch 2 below.

### Z-Ion Circuit Board Layout

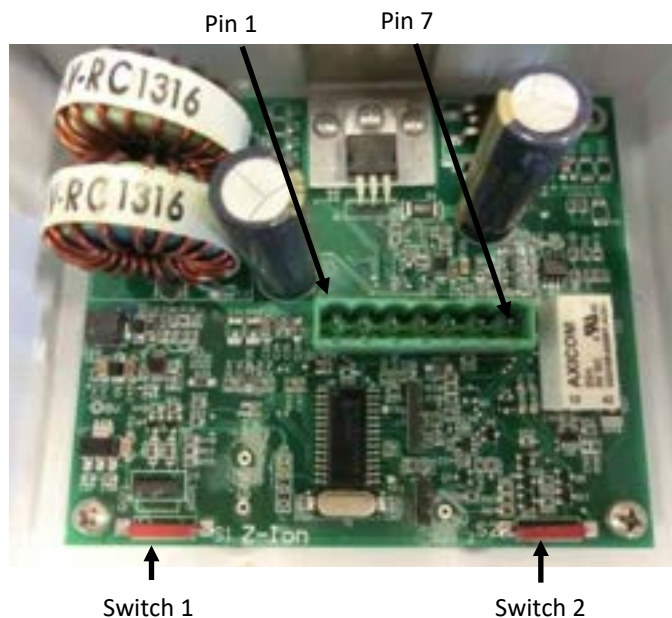



# Operation

# New System Startup

Every new system is shipped from the factory with nontoxic, food-grade propylene glycol. Propylene glycol, Spectra Chemicals, or anything other than seawater or freshwater must be purged from the system with the pressure relief valve open at least 1/2 turn. You can purge your system with seawater or freshwater via the Spectra's freshwater flush function. The system must be purged for a minimum of 20 minutes, or until at least 35 gallons of water have moved through the system.

**Warning! Damage will occur if the purge process is not properly followed and the membrane is pressurized with chemicals in it.**

Follow this procedure for starting a new system the first time, and after a system has been stored or cleaned with chemicals.

1. First check that:

- All of your hose connections are tight.
- The green warning tag and washer have been removed from under the pressure relief valve.
- The pressure relief valve is open at least 1/2 turn.
- The sampling valve is set to the sample position.
- The brine line is able to freely discharge

**Remove Tag and Washer**



**Open 1/2 Turn**



**Sampling Tap to Sample**



For a purge with seawater

- Move to an area free of contaminated water, such as in a polluted harbor or canal.
- The inlet thru hull/seacock is open

For a purge using the freshwater flush

- The vessel's pressurized water system is on
- The grey flush valve is open (horizontal)

**Flush Valve**



2. Turn on feed pump and check to make sure water is coming out of the brine discharge (thru-hull above water).

3. Run the system without pressure for 20 minutes to purge the storage chemicals. The pressure gauge should read less than 35 PSI. If purging with freshwater the sampling tube may discharge water.

4. Close the pressure relief valve. The pressure should rise to 60-80 PSI (4.2-5.7bar) on a Ventura 150 and 80-90 PSI (5.5-6.5 bar) on a 200T. Water should begin to flow out of the sampling tube. If the ship is located in brackish or fresh water the pressure will be lower.

Depending on storage and environmental conditions the system may need to have additional purging time. If the product water does not taste pure or sample below 500 ppm, purge or run the system for up to 6 additional hours.



## Normal Operation and Fresh Water Flush

If the system has been pickled, stored, or contains cleaning compounds, use the **New System Startup procedure**. The system should be fully run tested before you leave port. If the location or weather prevents proper testing refer to the next page, "Testing with an Artificial Ocean."

**THE VENTURA 200T IS DESIGNED FOR WARM WATER USE. OPERATION IN WATER BELOW 50 DEG F (10 DEG C) MAY CAUSE HIGH OPERATING PRESSURES AND INCREASED WEAR**

1. Check that the thru-hull inlet is open.
2. Turn the product sample valve to the SAMPLE position.
3. Turn the yellow service valve on the feed pump module to RUN.
4. Start the feed pump (switch the metal toggle switch on the feed pump module to ON) and check for flow by inspecting the brine discharge and checking for pressure on your analogue gauge. If there is no flow open the pressure relief valve on the Clark Pump to prime the system and bleed the air out of the feed pump.
5. After 5 minutes check the product water with your handheld salinity tester. When it is below 750 PPM, divert the product into your tank by rotating the product sample valve handle 90 degrees.
6. Run the system until you have filled your tank or have made enough to meet your requirements.

Product Sample Valve



Analogue Gauge Panel



### Fresh Water Flush (You should fresh water flush your watermaker after every use.)

1. Turn the yellow service valve to OFF. Open the grey flush valve on filter housing at the top of the feed pump module
2. Turn the toggle switch ON and flush for 3 minutes. Pressure will drop on the gauge, which indicates that the membrane is flooded with fresh water. Turn the toggle switch OFF.
3. Return the yellow service valve to RUN. Close the grey flush valve.

You may now leave the system unattended for up to five days (30 with the Z-Ion) without further attention

Remember that you need to run the system almost a half an hour to make enough water for a flush. You may notice that the system output is higher while charging your batteries, as the machine is voltage sensitive.

### Feed pump module with valves in the "Run" Position:



### Feed pump module with valves in the "Flush" Position:



# Testing with an Artificial Ocean

If it is not possible to test run the system with the boat in the water, testing may be accomplished with an artificial ocean. You will need 1.3 lbs. of non-iodized salt (rock salt, sea salt, or aquarium salt) to make 5 gallons (605 grams of salt per 20 liters) of seawater that is about 33,000 PPM salinity (average Seawater salinity). A good rule of thumb is 1/2 cup (.12 liters or 32 grams) of salt per gallon (4 liters) of water. If a hydrometer is available, mix to a specific gravity of 1.025. Make sure the domestic water system is powered up and the boat's tank has at least 30 gallons (120 Liters) of water to purge the storage chemicals from the system. Confirm that the charcoal filter is installed, and the domestic water line is connected.

1. **Open pressure relief valve on the Clark Pump. Remove the green tag and spacer! Leave the Pressure relief valve open half a turn.**
2. Turn the yellow service valve on feed pump module to OFF.
3. Open the grey flush valve on the charcoal filter housing.
4. Start the feed pump (Flip metal toggle switch to ON). Let the feed pump run for 20 minutes to purge the storage chemicals.
5. Stop the feed pump (metal toggle switch to OFF) and close the grey flush valve.
6. Connect the inlet service hose to the service port on feed pump module A, then connect the brine discharge service hose to the quick disconnect fitting on Clark Pump. Refer to the photo below. Route both hoses into the 5 gallon (20 Liter) container. Turn the product sample valve to the sample position, and route the **product** into the bucket.
7. Open the grey flush valve and turn on the feed pump. Fill the container with fresh water. Stop the pump and close the grey flush valve.
8. Turn the yellow service valve to SERVICE.
9. Mix the salt to the proper proportion or use an aquarium hydrometer to adjust the salinity level.
10. Start the feed pump, allow to prime, then close the pressure relief valve. The system will build pressure and start making water, with the product and brine recombining in the container to be cycled again.
12. Run the system under pressure, checking for proper operation and leaks.

After testing the system, stop the feed pump. Remove the inlet service hose and the brine discharge hose. Turn the yellow service valve to RUN. Perform a fresh water flush. A fresh water flush will hold the system for 5 days (30 with the Z-Ion). For longer periods we recommend a storage procedure.

Valves in flush position:

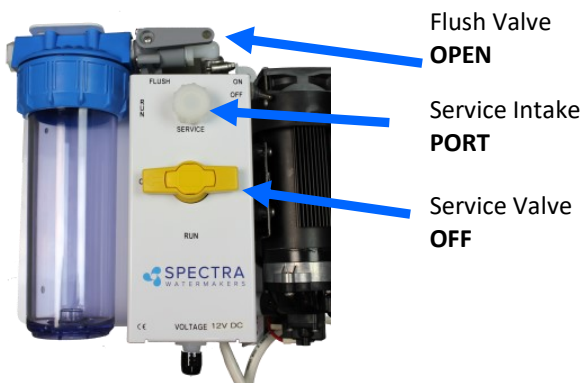

Valves in service position:

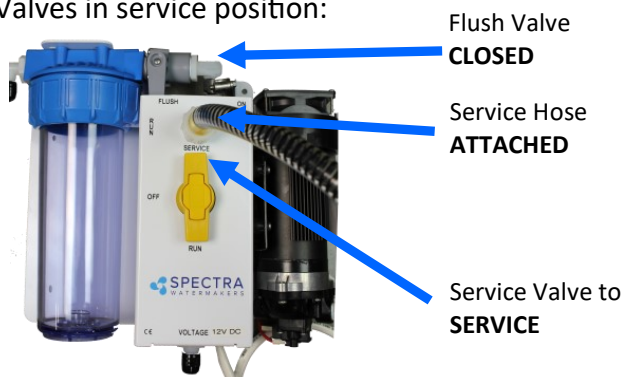

Open the pressure relief valve  
On Clark Pump:



Connect the brine discharge service hose:



## Optimizing the Fresh Water Flush Duration

Three minutes is usually the right flush duration to ensure that sea water is thoroughly flushed out of the watermaker using the least amount of fresh water. However, due to different lengths of hose runs, different rates of flow, and different pressures in shipboard fresh water systems, the flush duration can be optimized for your boat: Your system may require more than three minutes to adequately flush the system, or you might need less time, allowing you to save more fresh water.

### **Optimize the time**

Ideally the salinity of the brine discharge will be completely fresh just as the flush cycle is completed. Using the brine discharge service hose, direct the brine discharge into a bucket. While the system is fresh water flushing, take repeated samples from the brine discharge and test it with a handheld salinity meter. When the PPM drops below 1000 you can consider the system to have been fresh water flushed, and note the elapsed time. This will be your optimum flush duration going forward.



# **Maintenance, Storage, and Troubleshooting**

# Suggested Spares

## Short term cruising, weekends, etc.:

We suggest a basic Cruise Kit A. This kit consists of six 5 micron filters and SC-1 storage chemical.

## Cruising 2 to 6 months at a time:

Two basic cruise kits, one replacement charcoal filter, one replacement feed pump head.

## Longer than 6 months:

Additional filters, Offshore Cruising Kit consisting of Clark Pump seals, O-rings, tools, and membrane cleaning chemicals. One replacement strainer screen, O-ring for strainer screen, O-rings for filter housings. Spare feed pump and/or spare feed pump diaphragm.

## Common Parts:

Item	Part Number
SC-1 STORAGE CHEMICAL	KIT-CHEM-SC1
SC-2 CLEANER	KIT-CHEM-SC2
SC-3 CLEANER	KIT-CHEM-SC3
BASIC CRUISE KIT A	KIT-BCK-A
OFFSHORE REBUILD KIT	KIT-OFFSH
5 MICRON FILTER	FT-FTC-5
CHARCOAL FILTER	FT-FTC-CC
5" STRAINER SCREEN	FT-STN-5S
OIL/WATER FILTER	FT-FTC-OW
FEED PUMP	EL-FP-12V or 24V
FEED PUMP HEAD	PL-PMP-SFPH
FEED PUMP DIAPHRAGM	EL-FP-DP
5" STRAINER O-RING	SO-STN-5SS
FILTER HOUSING O-RING	SO-FHS-10H
CHARCOAL FILTER HOUSING O-RING	SO-FHS-3PCS10

# Maintenance

## General

Periodically inspect the entire system for leakage and chafing. Repair any leaks as soon as you find them. Some crystal formation around the Clark Pump blocks is normal. Wipe down any salt encrusted areas with a damp cloth.

Watermakers are at their best when run regularly. Biological fouling in the membrane is more likely when a watermaker sits idle. A warm environment will cause more growth than a cold environment. A fresh water flush every five days will greatly reduce biological growth but may not stop it completely. You can also protect your watermaker with the optional Z-Ion system, which protects the membrane and filters from bio-fouling without the use of storage chemicals.

## The Seawater Strainer

The seawater strainer's stainless steel element should be inspected, removed, and cleaned as needed. Ensure that the thru-hull is closed before disassembly and the gasket is in place before reassembly. When the system is put into storage, remove the strainer, rinse with fresh water, and reassemble dry to impede corrosion. Check frequently during operation.

## The Pre-filter

Service the pre-filter on a regular basis. On a Ventura the pressure will drop on the remote gauge when the filter becomes dirty, if the system is installed as pictured in the plumbing schematic. Extremely dirty filters will harm system performance and may cause the feed pump to cut out from high pressure. Leaving dirty filters in the machine during long idle periods will cause biological contamination.

To service the pre-filters, turn yellow service valve on the feed pump module to OFF, open the housing, and remove the old filter. Clean out the housing bowl and reassemble the housing with a new 5 micron filter element. Leave dry until next startup. Use only Spectra-approved filters or you may void your warranty.

The filters may be cleaned several times and reused, either by hanging overboard overnight from a rocking boat, dragging behind your vessel underway, or by gently spraying with a hose. Drying in the sun helps remove odors. If a filter element show any evidence of damage or fraying, discard it. Occasionally, lightly lube the filter housing O-ring with silicone grease.

## Oil Water Separator (Optional)

For oil/water separation, install an additional filter housing with an oil removal filter *upstream* of the 5 micron filter. Service at the same time as the 5 micron filter.

## The Charcoal Fresh Water Flush Filter

Replace the charcoal filter element at least every 6 months. This filter protects the membrane by removing chlorine from the flush water. Use only a Spectra-approved replacement.

## Maintenance Continued...

### The Feed Pump and Clark Pump

The feed pump and the Clark Pump require no routine maintenance except inspection for leaks. Tighten any hose clamps or fittings that show signs of leakage. The high pressure fittings threaded into the Clark Pump have O-ring seals with a straight thread. These should never leak and should never be over-tightened. If one of the tube nuts starts to leak, it can be unthreaded, sealed with a bit of silicone grease or oil, and tightened with two wrenches very tightly.

### The Membrane

Always perform a flow test before cleaning your membrane. Cleaning with chemicals shortens the lifespan of membranes, so only clean if you are certain it is warranted. The leading cause of fouling is biological growth that forms when the system is left unused without flushing or pickling. Fouling from mineral scaling can happen during operation under certain seawater conditions, and from rust. Monitor the product salinity and feed pressure for higher than normal readings, and take environmental conditions into consideration:

- Cold feed water or clogged filters can cause high pressure.
- Low product flow is usually due to low voltage, a worn feed pump, or worn Clark Pump.

**Test to see if biological growth has occurred:** Before running the system, remove the pre-filter and examine its condition. If the filter housing is full of smelly, discolored water, the system was not properly stored. Install clean pre-filters.

Next check the membrane. Attach the brine discharge service hose and lead it to a bucket. Open the pressure relief valve half a turn, and run the system for 30 seconds (metal toggle switch on feed pump module). Examine the brine water: If it is discolored and smells bad, perform an SC-2 cleaning with unchlorinated water before running the system pressurized. If the brine is fairly clean, follow the “new start up procedure” and run normally. Check for performance. Clean the membranes **only if** performance is reduced.

See the **Cleaning Procedure** for complete instructions.



## INTRODUCTION TO SPECTRA CHEMICALS

We use four types of chemicals: SC-1, SC-2, SC-3, and propylene glycol antifreeze. SC-1 and propylene glycol are for system storage, while SC-2 and SC-3 are for membrane cleaning.

**Note: Never use any chemicals with the system pressurized!** Always open the pressure relief valve 1/2 turn. Always follow the instructions for purging the chemicals as shown in the New System Startup section.

**Storage:** SC-1 prevents biological growth when your system sits idle. It should not be used as a cleaning chemical, nor will it protect your system from freezing. An 8 oz. bag of SC-1 is mixed with three gallons of product or dechlorinated fresh water and circulated through the system for 10 minutes. This treatment will protect the system for six months, after which the SC-1 treatment must be repeated. To use SC-1, follow the instructions for **Storage Procedure**.

Spectra systems should be stored with propylene glycol if freezing is likely to occur. Propylene glycol can be used instead of Spectra SC-1 storage chemical for storage in any climate, and treatment is effective for one year. Propylene glycol is a food-grade antifreeze used to winterize RV's, boats, and cabins. Do not use ethylene glycol automotive antifreeze, which is toxic and will damage the system.

The propylene glycol formulations sold in marine and RV stores are usually diluted with water. The water remaining in the watermaker before the storage procedure will further dilute the antifreeze, reducing the microbial protection and increasing the temperature at which the mixture will freeze.

Antifreeze labeled "Minus Fifty" is a 25% solution and will begin to form an icy slush at about +15Degrees F (-10C) and will only provide burst protection to about Zero F (-18C). After a further 50% percent dilution by water remaining in the watermaker, "Minus Fifty" antifreeze will only protect from bursting down to about +25F (-4C). Therefore if low temperature freezing protection is required a 60% or stronger antifreeze should be used. 60% solutions are labeled "Minus 100" and will provide burst protection to -15F (-27C) even after a fifty percent dilution with residual water. "Minus 200" formulations are pure propylene glycol.

Complete microbial protection requires a 25% solution of propylene glycol, so care must be taken that the solution remaining in the watermaker during long term storage is at least 25%, even if freeze protection is not required. For these reasons Spectra recommends that all pickling be carried out with a 60% or greater concentration.

See **Winterizing with Propylene Glycol**.

## Introduction to Spectra Chemicals continued...

Propylene glycol can be difficult to flush from a membrane, especially after extended storage periods. This results in high salinity water (high PPM) and residual flavor in the product water. We recommend flushing the system WITH THE PRESSURE RELIEF VALVE OPEN for 4-6 hours after storage with propylene glycol—the longer the better. If, after extended flushing, you still experience low product water quality, cleaning with SC-2 usually removes all traces of propylene glycol and returns the salinity to the level it was before storage with propylene glycol. See the **Cleaning Procedure**.

**Note:** Do not use metasodium-bisulfate, Citric Acid, or any other storage chemical not supplied by Spectra. These chemicals, used to store other watermaker brands, are very acidic and will damage the Clark Pump and void the warranty.

**Cleaners:** Cleaning can be detrimental to the membrane and shorten its life. Avoid unnecessary cleaning. Avoid cleaning as a diagnostic tool.

SC-2 is an alkaline cleaner used to remove light oil, grime, and biological growth. It is most effective if heated to 120 deg. F (49 deg. C), which is difficult on a boat. In most cases the water quality will increase in PPM (salinity) after an SC-2 cleaning. After a few hours it should recover to near the level it produced before the cleaning.

SC-3 is an acid cleaner used to remove mineral and scale deposits. In most cases this is used first and if there is no improvement, go on to the SC-2. SC-3 will in most cases lower the product PPM and overall pressures. Scaling is a slow process that may take several months or years. SC-3 is less harmful to the membrane and will almost always improve the performance of an older membrane.

For cleaning with either SC-2 or SC-3, see the **Cleaning Procedure**.

# Storage Procedure

NOTE: The Ventura contains about 2 gallons of water at any given time, so with 2 gallons in the bucket there will be a total of 4 gallons of solution.

1. Perform a normal fresh water flush (Refer to Normal Operation and Fresh Water Flush. Turn off the feed pump and close the grey fresh water flush valve. Leave the yellow service valve OFF.
2. Disconnect the brine discharge hose from the Clark Pump, and replace with the brine service hose from your service kit. Lead the service hose to a 5 gallon bucket.
3. Do another fresh water flush (open flush valve & turn on feed pump.) Turn off the feed pump and close the grey fresh water flush valve when the bucket has filled with 2 gallons of fresh water.
4. Mix one 8 oz. container of SC-1 storage compound with the water in the bucket. It will not dissolve completely, which is normal, and any undissolved particles will be caught by the pre-filter.
5. Connect the service hose to the service port above the yellow valve on the feed pump module and lead the hose into the solution in the bucket. Turn the yellow service valve to SERVICE.
6. **Make sure the pressure relief valve on the Clark pump is Open (unpressurized), 1/2 turn counter-clockwise OR THE MEMBRANE WILL BE DAMAGED.**
7. Turn on the feed pump. The system will draw solution from the bucket and return it via the brine discharge hose. Circulate the storage solution through the system for 15 minutes. Turn off the feed pump when finished.

## Clean Up:

1. Remove the brine service hose from the Clark Pump brine discharge, and replace the original hose that leads to the discharge thru-hull.
2. Turn the yellow service valve back to RUN. Remove the intake service hose, and replace the cap.
3. Close the seacock, drain then clean the sea strainer and pre-filters. Reassemble dry with new filters. Your system is now protected for the next six months.

## Feed Pump Module Valves in **flush position**:



## Opening the pressure relief valve On Clark Pump:



## Valves in **service position**:

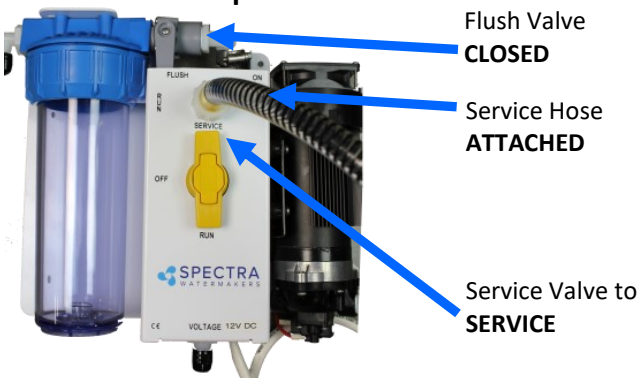

## Connecting brine discharge service hose:



# Winterizing with Propylene Glycol

**Warning! Use only potable water antifreeze (Propylene Glycol).  
Do not use automotive antifreeze (Ethylene Glycol).**

Propylene Glycol is an effective biocide and antifreeze. Purchase the strongest antifreeze available. See "Introduction to Spectra Chemicals" for additional details.

1. Fresh water flush the watermaker. (Refer to Normal Operation and Fresh Water Flush). Turn off the feed pump (metal toggle switch in top right corner of feed pump module). Close the grey flush valve (located on feed pump module).
2. Connect the inlet service hose to the service intake on the feed pump module, and lead it into a bucket. Connect the brine discharge service hose, and run it into a second container.
3. Turn the yellow service valve to the SERVICE position.
4. Pour 1 gallon (4L) of propylene glycol of appropriate concentration into the bucket with the intake service hose.
5. **Make sure that the pressure relief valve on the Clark Pump is OPEN a 1/2 turn, OR THE MEMBRANE WILL BE DAMAGED.**
6. Run the feed pump until about a gallon of water has flowed from the brine discharge service hose, or antifreeze appears. Propylene glycol will look slightly different, and feel more slippery, than water. Stop the pump. Add more propylene glycol to the intake bucket if necessary.
7. Lead the brine discharge service hose into the same bucket as the intake service hose. The system will now draw propylene glycol solution from the bucket with the intake service hose and return it via the brine discharge service hose.
8. Run the feed pump to circulate the antifreeze in this manner for 10 minutes.
9. Stop the feed pump. Reconnect the brine discharge hose that leads to thru-hull. Run the feed pump until the bucket is empty.
10. Close the seawater intake. Turn the yellow service valve to OFF. Drain the seawater strainer and the hose leading to the feed pump module. Disconnect the product tubing from the membrane housing and blow the water out. Empty the charcoal filter housing and flush water lines.

Your watermaker is now protected from biological growth and freezing for one year.

Opening the pressure relief valve:



Connecting brine discharge service hose:



Valves in **SERVICE** position:



Feed pump module valves in **FLUSH** position:



# Cleaning Procedures

**Note: Procedures are the same for the SC-2 and SC-3 cleaners.**

An 8 oz. jar of Spectra cleaning compound (SC-2 or SC-3) must be mixed with fresh water at a ratio of 1 container of compound to 3 gallons (12L) of unchlorinated fresh water. **An average of two gallons (7.6L) of water is already present inside a Ventura system,** and this water will be figured into the mixture.

Warm water is ideal for cleaning membranes: Use a large stainless steel pot to heat the solution to 120°F (49°C). You might have to periodically stop and reheat the solution.

1. Perform a fresh water flush (Refer to Normal Operation and Fresh Water Flush). Stop the feed pump and close the grey flush valve.
2. Connect the inlet service hose to the service intake on the feed pump module. Connect the brine discharge service hose to the quick disconnect on the Clark Pump. Lead the two hoses into a bucket. Open the grey flush valve and run the feed pump until you have one gallon (3.8L) of water in the bucket.
3. Turn off the feed pump and shut the grey fresh water flush valve.
4. Turn the yellow service valve on feed pump module to SERVICE.
5. **Make sure the pressure relief valve on the Clark Pump is OPEN 1/2 a turn (system is un-pressurized) OR THE MEMBRANE WILL BE DAMAGED.**
6. Mix the cleaning chemical with the gallon of water in the bucket.
7. Start the watermaker and circulate the chemical through the system for 45 minutes, if the solution is warm. Let the solution sit in the unit overnight if the cleaning solution is cold.
8. Stop the pump, replace the brine discharge hose, and run the pump until the bucket is empty. Stop the feed pump and turn the yellow service valve to RUN. Follow the instructions for New System Startup. **(KEEP THE PRESSURE RELIEF VALVE OPEN!)**

Feed Pump Module Valves in **flush position:**



Opening the pressure relief valve On Clark Pump:



Valves in **service position:**

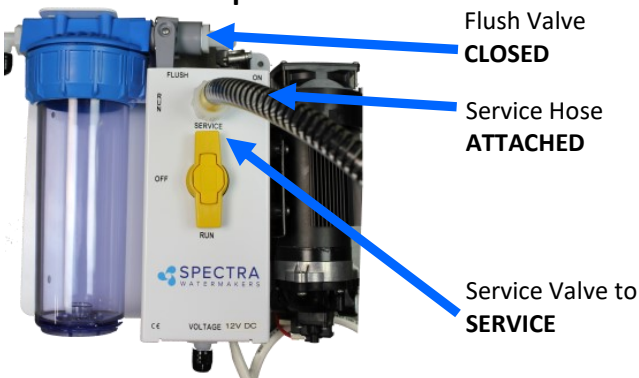

Connecting brine discharge service hose:



## Flow Test

The flow test is the most useful diagnostic test for system performance, and should be done before replacing or cleaning your membrane. Changes in production or water quality are normally caused by something **other than** the membrane, unless the system has been left unused for a long time.

Before the flow test, change all filters and clean the sea strainer. Carefully check for water or air leaks, as air in the system will cause low production and erratic salinity. Look for air bubbles in the product flow meter, feed water hoses, and brine overboard hose. When the system has been running and is stabilized use a multimeter to confirm at least 12.5 Volts are at the feed pump on 12-Volt DC systems; 25 volts on 24-Volt DC systems. If available, turn on engine or battery chargers.

Run the system and watch the feed pressure very closely. If the feed pressure to the Clark Pump is asymmetrical from one stroke to another, this impedes performance. A difference of a few PSI is acceptable, but anything over that is an issue. If the pump is asymmetrical, Clark Pump repairs should be done before continuing with these tests. If no asymmetry is noted, continue with this test.

Make sure the ShurFlo overpressure cutout switch (PL-PMP-SFPH) is set to 125 PSI. With the pump running, close the brine discharge thru-hull or kink the brine discharge hose. The feed pressure should rise to 125 PSI, then the pump should shut off. If the pump shuts off at a lower pressure see the Adjust ShurFlo Pressure Switch Tech Bulletin. Log the voltage at the feed pump terminal block before taking measurements from each test.

You will need a stopwatch and container to measure two flow rates; the product water flow rate and the total or feed flow rate. Total flow is the product flow combined with the brine discharge flow (Pressure Relief Valve closed). Nominal flow rates for product flow are given in gallons per hour and nominal flow rates for total flow are given in gallons per minute. Calculations are much more simple when a 1, 2, 3, 5, or 10 minute test are taken in a graduated bucket, graduated pitcher or large measuring cup. However, if these are not available, you can count the number of seconds or minutes it takes to fill a container with a known quantity; i.e. 5 gallon bucket, milk jug, wine bottle, etc.

The ratio of product flow to total flow gives us our recovery rate, as a percentage. The Clark Pump is designed to have a fixed recovery ratio percentage.

Product flow rate, total flow rate, recovery percentage, feed pressure, voltage and product quality all need to be considered when diagnosing system performance.

If you are making above the minimum value for Product Flow and the quality is below 500 ppm, the system is functioning normally.

For remedies and suggestions on how to improve these values see Troubleshooting.

## Flow Test-Continued

Once you have taken the test compare the results to the table below.

System	Feed Pressure		Static * Pressure	Total/Feed Flow				Product Flow				Recovery %		
	PSI	bar		GPM	LPM	MIN	MIN	Normal Flow	MIN	MIN	Nominal	Actual	Min	
			PSI											GPM
Ventura 150	60-70	4.2-5	10 to 15	1.7	6.4	1.65	6.2	6.5	24.6	5.7	21.5	7	6.5	5.5
Ventura 200	80-90	5.6-6.3	20 to 25	1.7	6.4	1.6	6	8.3	31.4	7.7	29.1	10	9	8.0

\*pressure relief valve open ½ turn

Below are examples of flow test calculations:

**Product Flow:** Raw measurements to GPH (Gallons Per Hour) or LPH (Liters Per Hour).

**Example 1 (round number) — In 5 minutes 2/3 of a gallon (0.66 Gal) of product water was collected.**

$$\frac{0.66 \text{ Gal}}{5 \text{ minutes}} \times \frac{12}{12} = \frac{7.92 \text{ Gal}}{60 \text{ minutes}} = 7.92 \text{ GPH}$$

**Example 2 (partial min) — It took 1 minute, 52 seconds to collect 0.25 Gallons of product water.**

$$\frac{52 \text{ seconds}}{\text{given}} \times \frac{1 \text{ minute}}{60 \text{ seconds}} = \frac{0.866 \text{ minutes}}{\text{given}}$$

i. Then 1 minute, 52 seconds = 1.866 minutes

$$\frac{0.25 \text{ Gal}}{1.866 \text{ minutes}} \times \frac{32.14}{32.14} = \frac{8.03 \text{ Gal}}{60 \text{ minutes}} = 8.03 \text{ GPH}$$

ii.

**Total Flow or Feed Flow:** Feed flow or total flow (brine + product) is expressed in Gallons Per Minute (GPM) or Liters Per Minute (LPM). If capturing brine individually remember to have the Pressure Relief Valve closed.

**Example 1— In 30 seconds 0.8 gallons of brine and product water was collected.**

$$\frac{0.8 \text{ Gal}}{0.5 \text{ minutes}} \times \frac{2}{2} = \frac{1.6 \text{ Gal}}{1 \text{ minute}} = 1.6 \text{ GPM}$$

**Example 2 — It took 3 minutes, 20.2 seconds to fill a 5 gallons bucket with brine.**

$$i. \frac{20.2 \text{ seconds}}{\text{given}} \times \frac{1 \text{ minute}}{60 \text{ seconds}} = \frac{0.336 \text{ minutes}}{\text{given}}$$

Then 3 minute, 20.2 seconds = 3.336 minutes

$$ii. \frac{5 \text{ Gal Brine}}{3.336 \text{ minutes}} \times \frac{17.98}{17.98} = \frac{89.92 \text{ Gal brine}}{60 \text{ minutes}} = 89.92 \text{ GPH Brine}$$

$$iii. 89.92 \text{ GPH Brine} + 8.03 \text{ GPH Product} = 97.95 \text{ GPH Total Flow}$$

$$iv. \frac{97.95 \text{ Gal}}{1 \text{ hour}} \times \frac{1 \text{ hour}}{60 \text{ minutes}} = \frac{1.63 \text{ Gal}}{1 \text{ minutes}} = 1.63 \text{ GPM}$$

**Recovery Rate:** The ratio of product flow to total flow gives us our recovery rate, as a percentage.

**Example 1**

$$i. \frac{1.6 \text{ Gal}}{1 \text{ mininute}} \times \frac{60 \text{ minute}}{1 \text{ hour}} = \frac{96 \text{ Gal}}{1 \text{ hour}} = 96 \text{ GPH Total Flow}$$

**Example 2**

$$\frac{8.03 \text{ GPH Product}}{97.95 \text{ GPH Total Flow}} = 0.0819 \times 100\% = 8.19\% \text{ Recovery}$$

$$ii. \frac{7.92 \text{ GPH Product}}{96 \text{ GPH Total Flow}} = 0.0825 \times 100\% = 8.25\% \text{ Recovery}$$



## Troubleshooting Ventura Systems

SYMPTOMS	PROBABLE CAUSE	REMEDY
Low product flow, more than 1 GPH, Total flow down (See Flow Test.)	Motor receiving less than 12.5VDC. A 0.5 VDC decrease at the feed pump motor can equate to a loss of 0.5 gallons product per hour. If possible, run diagnostic tests when the system is getting at least 13.2 VDC.	Check for voltage drop. Increase wire size if necessary.
		Check Power Supply.
		If available, turn on battery chargers.
	Blockage or restriction in the system.	Replace prefilter, service strainer, and check all hose runs.
	Thru-hull blockage	Confirm by using intake service hose and bucket of seawater to bypass thru-hull Clean thru-hull.
	Mineral scaling	Perform SC-3 Cleaning. <i>Note: By design, it is rare for the membrane to cause low total flow on Spectra Systems.</i>
	Pump or Motor worn	Confirm by attempting pressure test (See Tech Bulletin). Strong pumps with good power should reach 125 psi within 3 seconds. Replace pump head.
Low product flow, Recovery percentage below minimum nominal value (See Flow Test)	Pressure Relief Valve open partially	Close pressure relief valve.
	Internal leak in Clark Pump	Complete service is recommended. Contact Dealer or see Clark Pump rebuild manual. Install Offshore Kit.
Asymmetrical pressure and flow readings between pump shifts – When one shift has 0 pressure	Internal leak in Clark Pump.	While system is running kink brine hose to stop flow until feed pressure rises to 115 psi, release hose quickly, repeat no more than 10 times.
		Inspect Clark Pump Check Valves.
Asymmetrical pressure and flow readings between pump shifts- more than a few psi	Scored Clark Pump annular rings and reversing valve spool	Replace.
	Scored Clark Pump piston rod and lip seals	Confirm by opening test port on back of pump. If constant flow, replace seals and circular sand (240 grit) or replace piston rod.
	Scored Clark Pump Cylinder(s)	Hone, circular sand (240 grit) or replace.



## Troubleshooting Ventura Systems

SYMPTOMS	PROBABLE CAUSE	REMEDY
No Product flow, good brine discharge flow. Recovery percentage is 0 (See Flow Test)	Internal leak in Clark Pump.	While system is running kink brine hose to stop flow until feed pressure rises to 115 psi, release hose quickly, repeat no more than 10 times.
		Inspect Clark Pump Check Valves.
		Complete service is recommended. Contact Dealer or see Clark Pump rebuild manual. Install Off-shore Kit.
Feed Pump not running, no noise	No Power At feed pump	Check voltage at feed pump.
	Pressure switch failed.	Adjust or bypass. To bypass, turn off power and pull off the 2 cables with push-on terminals and connect them together with a piece of electrical cable pushed into each terminal. Do not run the pump for long, just to diagnose failure.
Feed pump runs intermittently cycling on/off	Overpressure switch on Feed pump opening	Adjust or replace switch.
Feed Pump runs with loud noise	Intake blocked	Check Through Hull.
	Air in system	Check sea strainer for leaks.
		Check freshwater flush module for leaks.
		Re-prime system (restart).
Feed Pump turns on but no pressure	Feed Pump air locked	Open pressure relief valve to bleed the air then close to start
	Pressure relief valve open	Close pressure relief valve.
Feed Pump Starts but shuts down on high pressure	Prefilter excessively clogged	Change prefilter.
	Closed valve or blockage in flow	Check flow path for closed valve or kink in hose.
High Feed Pressure, High Amperage, and Product flow down up to 15%	Colder or more saline seawater	Normal Condition.
	Brine or product flow observing back pressure	Confirm by running both into a bucket.

## Troubleshooting Ventura Systems

SYMPTOMS	PROBABLE CAUSE	REMEDY
	Scaled or Fouled Membrane	Clean membrane.
Low Feed Pressure, Low Amperage	Warm seawater or brackish water	Normal Condition.
PPM rises steadily while pressure and production remain constant	Membrane needs to be replaced	Consult dealer and replace membrane.
PPM high	TDS meter needs calibration	Re-calibrate TDS meter or taste test water until you are able to replace.
	Feed flow or Clark Pump problem	Low product flow, recovery percentage or feed pressure can lead to drop in product water quality, perform Flow Test and address flow issue.
	Membrane was fouled or damaged	Clean membrane or consult dealer about membrane damage when product flow and pressure are at spec levels but water tastes salty.
	Fouled Prefilters	Freshwater flush procedure needs to be tested and adjusted. Replace filters or run watermaker for an extended period of time to rinse.

# Technical Bulletins

The following pages include Spectra's most commonly-used technical bulletins, addressing tests, adjustments, troubleshooting, and common points of confusion.

## DWYER FLOW METER SERVICE

The mechanical flow meter, PL-FMT-10 (10 GPH range) or PL-FMT-20 (20 GPH range) can be opened for cleaning if it becomes difficult to read or if the little ball gets stuck.

The flow meter will come completely apart for cleaning. First remove the meter from the panel. Remove the four small screws that hold the stainless steel bracket in place. Carefully pry off the bracket. On the very top of the meter is a clear plastic slide-off cover over an Allen screw. Use a flat bladed screwdriver to push the cover off. Holding the meter upright, remove the Allen screw with a ¼" Allen wrench. Invert the flow meter and catch the ball as it falls out. You can use tooth paste or plastic window polish to polish the inside using a small bottle brush. Clean the ball and give it a few coats of wax. If the O-rings are damaged or the unit has been leaking, install new O-rings using a little silicone grease to ease assembly. These are standard O-rings and should be available at most larger auto parts or bearing stores. Reassemble in reverse.

## ACCUMULATOR PRESSURE

Your Spectra watermaker is supplied with a pressure accumulator tank (PL-ACC-TK), which should be installed in the feed water line between the pre-filters and the Clark Pump.

The purpose of the feed line accumulator is to reduce the spikes in the feed pressure caused by the cycling of the Clark Pump. If the accumulator is not properly charged it can lead to problems with the Shurflo Pump pressure cutout switch. The accumulator has a Schrader air valve, like a car tire, which allows the internal air bladder of the accumulator to be pre-charged. The accumulator should be pumped up to about 65 psi (4.5 bar) for best results. Add air using a tire pump or air compressor. You can experiment with the exact pressure that will give the best pulsation dampening on your installation.

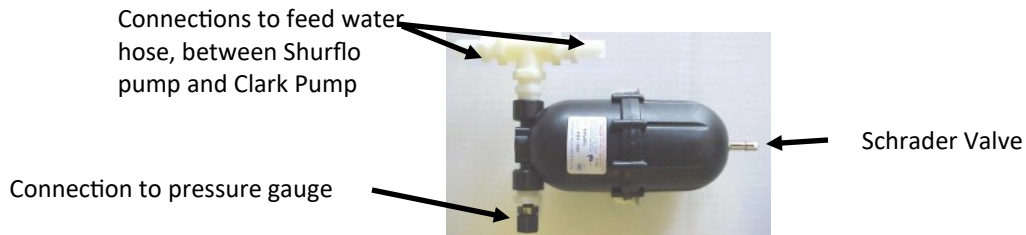

## PRE-FILTERS

A Ventura system uses two different filters to prevent damaging foreign materials from entering the system. A single 5 micron filter cleans the feed water of abrasive materials while the system is in operation; an additional carbon filter prevents the entrance of chlorine during fresh water flushing.

During normal operation, the feed water is filtered in two stages. First it passes through a fine mesh metal sea strainer, which protects the feed pump from foreign materials and sea creatures. After passing through the feed pump, the feed water passes the filter housing containing the 5 micron element, removing very fine particles that could damage the Clark Pump and shorten membrane life.

Replacement schedules will vary widely depending on how and where the system is used. If large amounts of feed water are run through the system over a relatively short period of time in biologically fertile near-shore waters, the pre-filter will plug up, water production and quality will drop, and the system pressure will change dramatically. If the pressure gauge was installed after the pre-filters, as pictured in the plumbing schematic, the pressure will decrease as the pre-filter becomes more clogged.

When operated for only an hour or two a day in inland or near-shore waters, the trapped plankton will begin to decay in the filter long before it plugs up. The decaying plankton and bacteria will cause a rotten egg smell in the product water. This decay will set in overnight in tropical waters, or after a week or two in higher latitudes. In crystal clear blue water conditions, the filters may need to be cleaned much less frequently.

If handled gently and changed regularly before they get too smelly, filters can be cleaned and reused several times.

To ensure that filter elements fit properly, they should be purchased from factory authorized dealers. Our filter element part number is FT-FTC-XX. The last digits indicate the micron rating, e.g. FT-FTC-5 is for a 5 micron element:



## CHARCOAL FILTERS

The charcoal filter element (FT-FTC-CC) removes chlorine from the fresh water flush water supply. The RO membrane can only handle small amounts of chlorine without permanent damage. If the fresh water flush water contains chlorine, the membrane will be exposed to it for days and will produce high salinity water.

The charcoal filter used for the fresh water flush system will not plug up unless you have very dirty domestic water in your boat's supply tank. About six months after installation the charcoal filter element will lose its effectiveness and must be replaced. This is purely a function of time, not usage.

The charcoal filter we supply removes 99.7% of the chlorine. Beware when buying other charcoal filters. If they don't specify the percentage of chlorine removed, don't use them. Cheap ones may remove only 60% or 70%. Also, there are aftermarket filters which are very close to, but not exactly the same dimensions, and will not seal properly in the housing. If you skimp on the charcoal filter you risk damaging a \$600.00 membrane on the first flush. The other factor is the flow rate that the filter can handle. Because the chlorine is adsorbed by the charcoal, it must remain in contact with the charcoal for a sufficient period of time for all of the chlorine molecules to be captured. The filters we use can handle 1.5 gallons (6 liters) per minute flow, and are good for 3000 gallons (12,000 liters) at 1.5 GPM, or six months, whichever comes first. Regardless of the flow, the charcoal loses its effectiveness after six months.

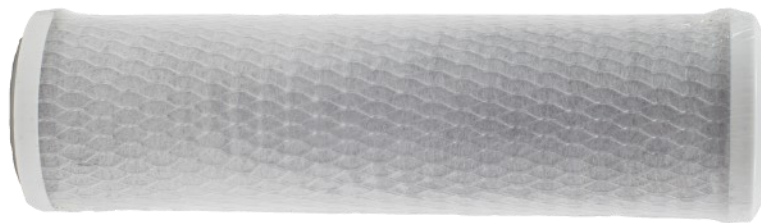

Charcoal filter, Spectra part number FT-FTC-CC

## SHURFLO PUMP WON'T RUN

If the pump has power to it but the pump won't run, first check the pressure switch. The pressure switch (EL-FP-PS) is located on the wet end of the pump and has two red wires plugged into it. Jump the two red wires together and see if the pump runs. You can safely run the system with the pressure switch jumped, just keep an eye on the pressure gauge and don't let system pressure exceed 110 PSI. Replace the switch when a spare is available. The pressure switch should never open unless there is a problem with the system or it is incorrectly adjusted. Check the accumulator pressure, the operating feed pressure, and the switch cut-out setting.

If the pump will not run with the pressure switch jumped then it is most likely a problem with the brushes or overheat protection switch inside the motor. The motor will come completely apart by removing the two screws on the end of the motor. Remove the rear cover and paper insulator. Pull out the plastic brush holder. The thermal switch is located on one of the brush leads. With an ohmmeter, check for continuity through the switch. If it is open, you can make temporary repairs by wiring around it, being careful that your new wiring doesn't chafe on the moving parts, nor resist the springs that push the brushes on to the commutator. The overheat switch is unlikely to fail unless the motor has overheated and shut down. Consider relocating the pump or improving ventilation if the overheat protection has failed.

If any corrosion is apparent the brushes may be sticking. Once apart clean all the carbon dust from all the parts. Clean the commutator with light sandpaper. Make sure to clean the small grooves on the commutator with a small sharp tool to remove the carbon in between the segments. Adjust the springs on the brush holders so the brushes slide smoothly in and out. If the bearings are rough and binding, remove the rubber dust cover and clean the best you can, grease them, and work them free by hand. Don't service the bearing unless absolutely necessary. Reassemble in reverse order. You can hold the carbon brushes back with papers clips inserted through the slots in the brush holder so they don't hang up on the bearing during assembly. Make sure the corrugated bearing shim doesn't push out, if it does, push it back into place.

## ADJUST SHURFLO PRESSURE SWITCH

Shurflo feed pumps are equipped with a high pressure cutout switch (EL-FP-PS). This is the small black unit on the end of the wet end of the pump head (PL-PMP-SFPH) where the two red wires connect. If the pressure switch is not properly adjusted the pump may cut out each time the Clark pump cycles and the feed pressure spikes. When this happens the production will drop and salinity will increase. The points in the switch will fail quickly if set too low because of the constant arcing each time the Clark Pump shifts.

On the very center of the switch is a small 5/64" Allen screw. While running the system close the brine discharge seacock or kink the discharge hose, to block the flow. Watch the pressure gauge and adjust the pressure switch to shut off at 125 psi. Turn the Allen screw clockwise to increase the cut off set point.



## Poor Product Water Quality

With any product water quality issue, you must ensure accurate calibration if you are using a salinity meter. For general quality evaluation, your taste is always good enough.

Membranes are not an exact science and two identical systems can have different product quality. World health standards deem water of up to 1000 PPM of total dissolved solids acceptable for drinking consumption. We consider anything below 750 PPM acceptable but not ideal, and anything below 500 PPM excellent. Factors that could affect water quality are addressed below.

**LOW SYSTEM FLOW OR PRESSURE** will equate to lower product quality (higher PPM).

Ventura systems, which have a higher feed to output pressure ratio (See nominal pressures under Flow Test), as well as a higher feed flow/membrane area ratio, will produce water in the 150-300 PPM range.

**DAMAGE TO THE MEMBRANE** by chlorine contamination. Flushing the system with chlorinated water will irreparably damage the membrane. Charcoal filters are used to adsorb any chlorine which might be present in flush water. They must be of proper specification to be suitable. There is no test for chlorine damage except the process of elimination of other causes.

**DIRTY OR SCALED** membranes. A dirty (foreign material), scaled (mineral deposits), or contaminated (bacterial growth) membrane can result in poor water quality and abnormal operating pressures. If operating pressures are above normal, then cleaning is indicated. If the system pressures are within normal operating range, cleaning may have little result. Avoid cleaning as a diagnostic tool. Low water quality after storage with propylene glycol can usually be remedied by extended flushing or an SC-2 cleaning.

**MECHANICAL LEAKAGE** within the membrane pressure vessel. This is an unlikely but possible cause of poor water quality. A pinched or damaged O-ring within the pressure vessel, a scratch on the product tube on the membrane, a scratch within one of the end caps, or a seal fouled by contamination could allow sea water into the product water.

If system flow (product plus brine) is 1.5 GPM or above, the membrane is clean, the product flows are consistent with the system flow and the water quality is still not acceptable, then replacement of the membrane is indicated.



# Part Numbers

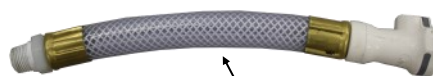

Plate Bracket  
FM-PVB-PB

Pump to Pressure Vessel  
Upper SS Tube:  
PL-TB-HP-HPTVUS

3/8" NPT x 5/8" NPT Hose Barb Ell Nylon  
PL-HBE-3/8x5/8

3/8" NPT Quick Disc.  
Coupling Body  
PL-QDC-BD3/8



INLET HOSE ASSEM.  
SUB-CT-Z-HPILHA

to Pressure Vessel  
SS Tube:  
HP-HPTPVLS  
(pictured)

Nickel-Bronze High Pressure Elbow  
PL-MTE-3/4S1/2B

Plate Bracket End  
FM-PVB-PBE

PRODUCT OUTLET FITTING  
PL-FTE-1/8X1/4P

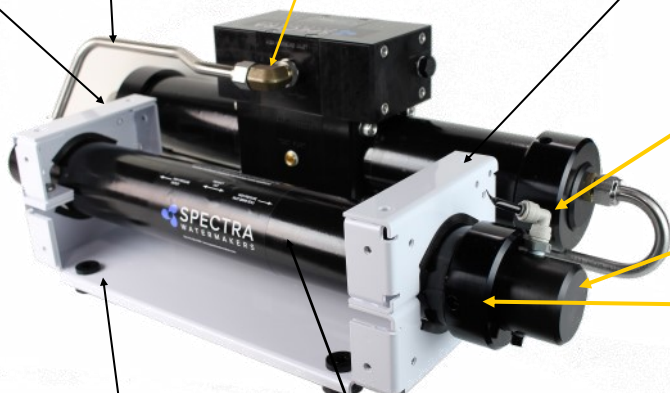

Pressure Vessel End Cap  
FT-PV-EP1

Pressure Vessel End Ring  
FT-PV-ER

Rubber Mount  
HD-RBP-RM  
Plastic Spacer  
HD-SPN-MKINS

20-Inch Hi Rejection Membrane  
FT-MB-20F

Nickel-Bronze High Pres-  
sure Straight Fitting  
SUB-MTS-3/8X1/2

3/4" -16 Straight Thread  
O-RING  
SO-FT-STF

1/2" Stainless Ferrule  
PL-HWR-1/2FR



Connector O-RING  
SO-HPP-CT

Stainless Fitting Hex Nut  
PL-HWR-1/2HN

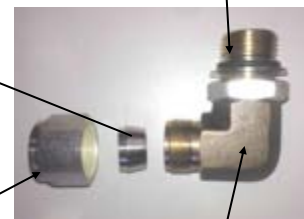

Nickel-bronze high pres-  
sure 90 degree fitting  
PL-MTE-3/4S1/2B

## Part Numbers continued...

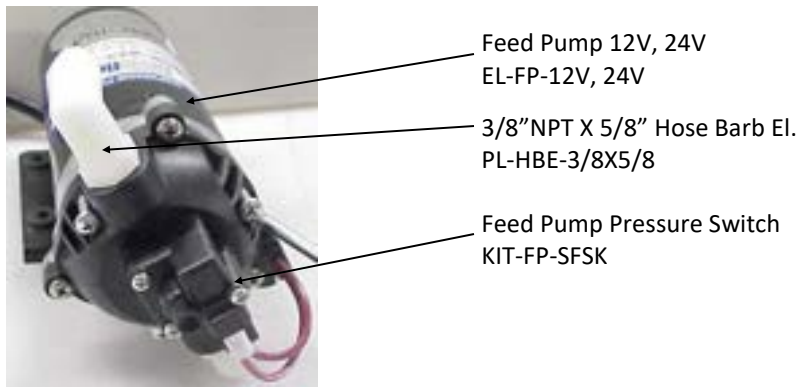
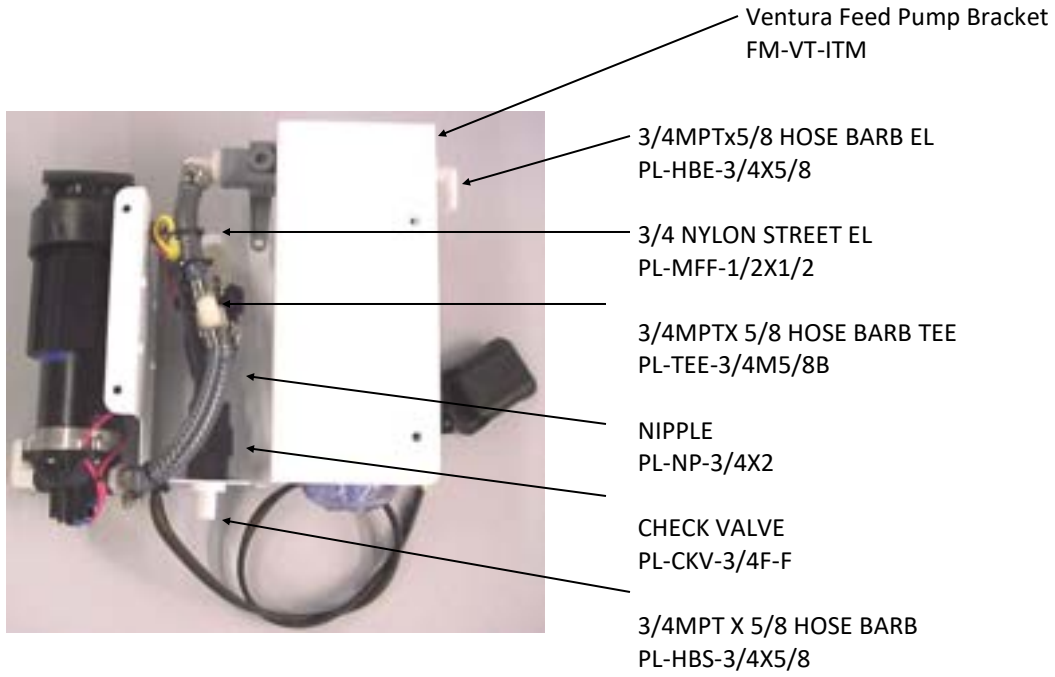
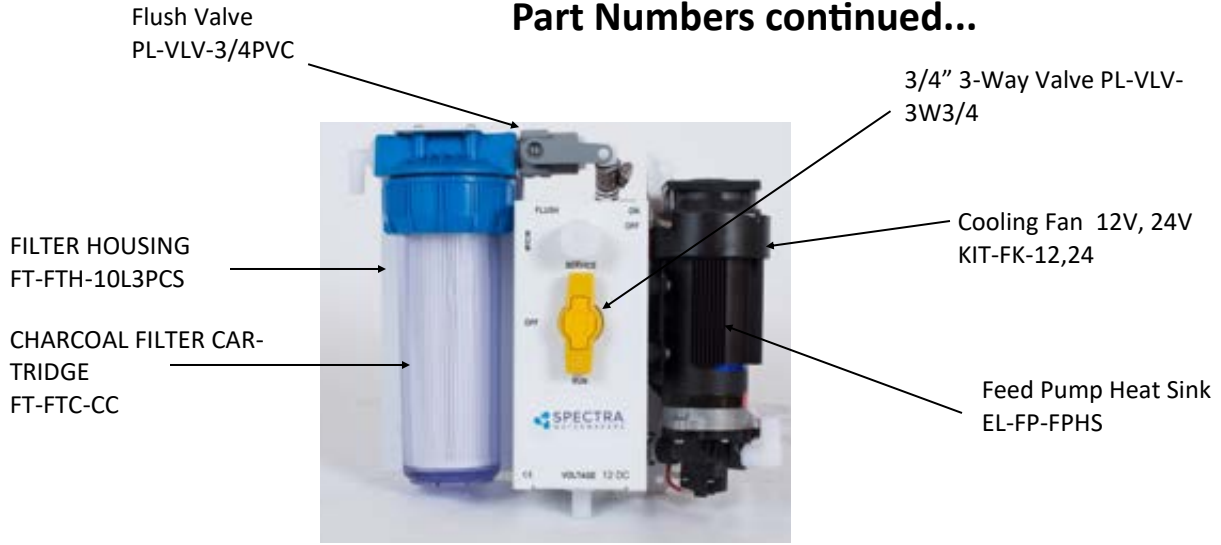

Fig 2

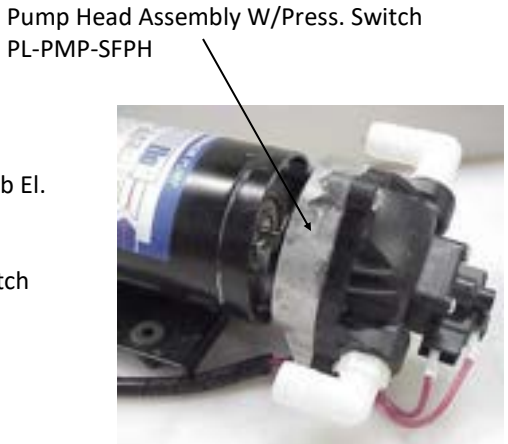

Fig 3

## Part Numbers continued...



PRODUCT WATER SAMPLING VALVE  
PL-VLV-3W1/4

1/4 TUBE X 1/4 MPT STRAIGHT FITTING

PL-MTS-1/4X1/4P

or

PL-MTE-1/4X1/4P

ELBOW FITTING 1/4 TUBE X 1/4 MPT EL (not shown)

Wall Mounting Clamps (not shown):  
(2)PL-CLP-3/4CAR 3/4" CARLON CLAMP

ACCUMULATOR  
PL-ACC-TK



1/2MPT X 5/8 HOSE BARB PL-HBS-1/2X5/8

1/2" TEE  
PL-TEE-1/2FN

1/2" NIPPLE  
PL-NP-1/2N

1/8MPT X 1/4 TUBE EL  
PL-MTE-1/8X1/4P

PRODUCT FLOW METER  
PL-FMT-10

1/4MPT X 1/4 TUBE STRAIGHT FITTING  
PL-MTE-1/4X1/4

1/2 X 1/4 BUSHING  
PL-BSH-1/2X1/4N

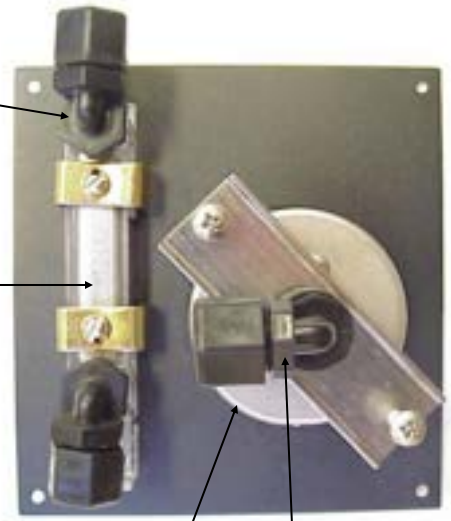

PRESSURE GUAGE  
PL-PSG-LP2.5

1/4FPT X 1/4 TUBE EL  
PL-FTE-1/4X1/4P

PREFILTER HOUSING  
FT-FTH-10H

5 MICRON FILTER CARTRIDGE  
FT-FTC-5



1/8"NPTX1/4" Tube fitting Elbow  
PL-SWF-1/8X1/4J

SEA STRAINER  
FT-STN-5

5" STRAINER O-RING  
SO-STN-5S

STRAINER SCREEN  
FT-STN-5S

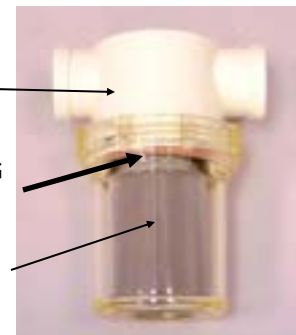

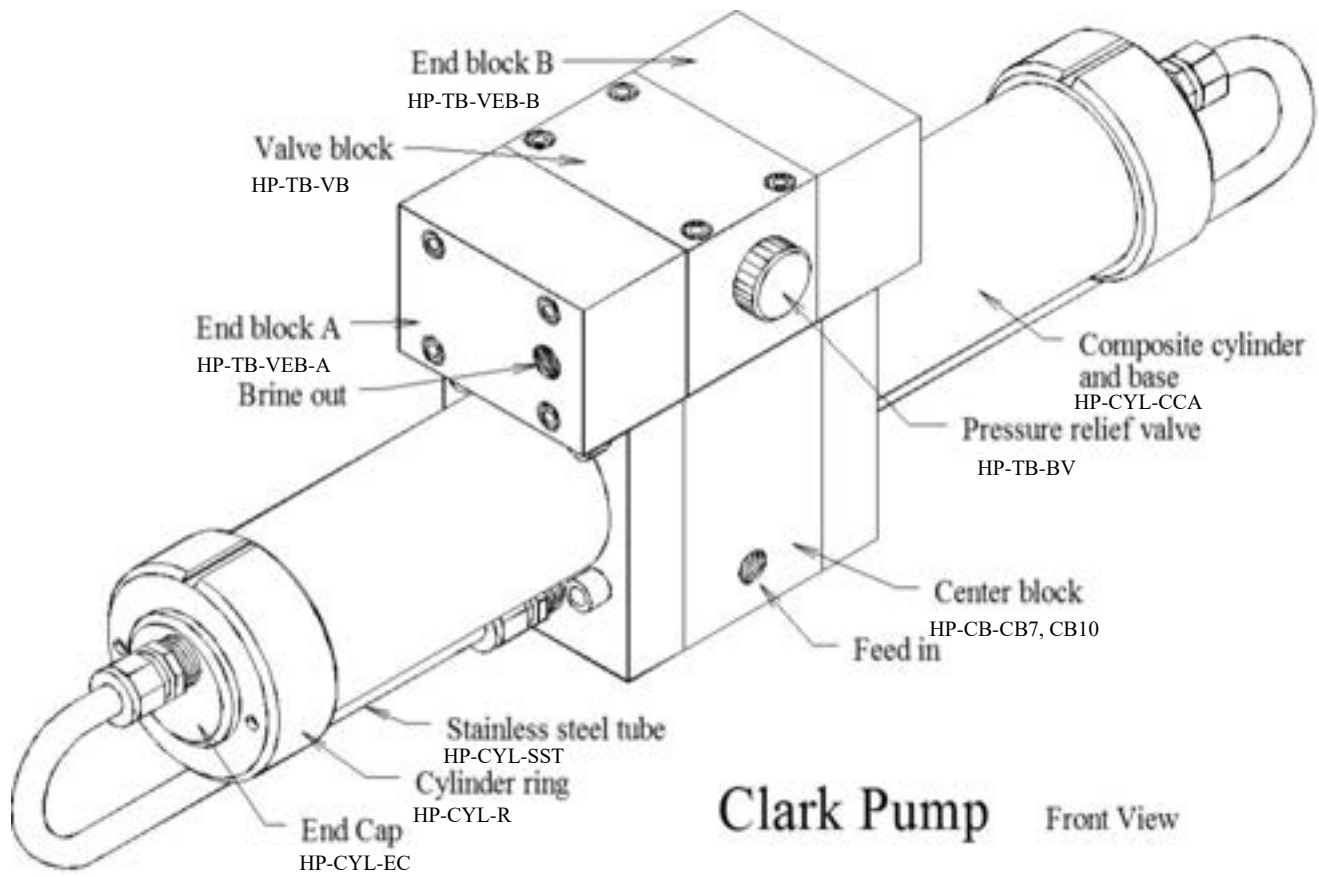

**Clark Pump** Front View

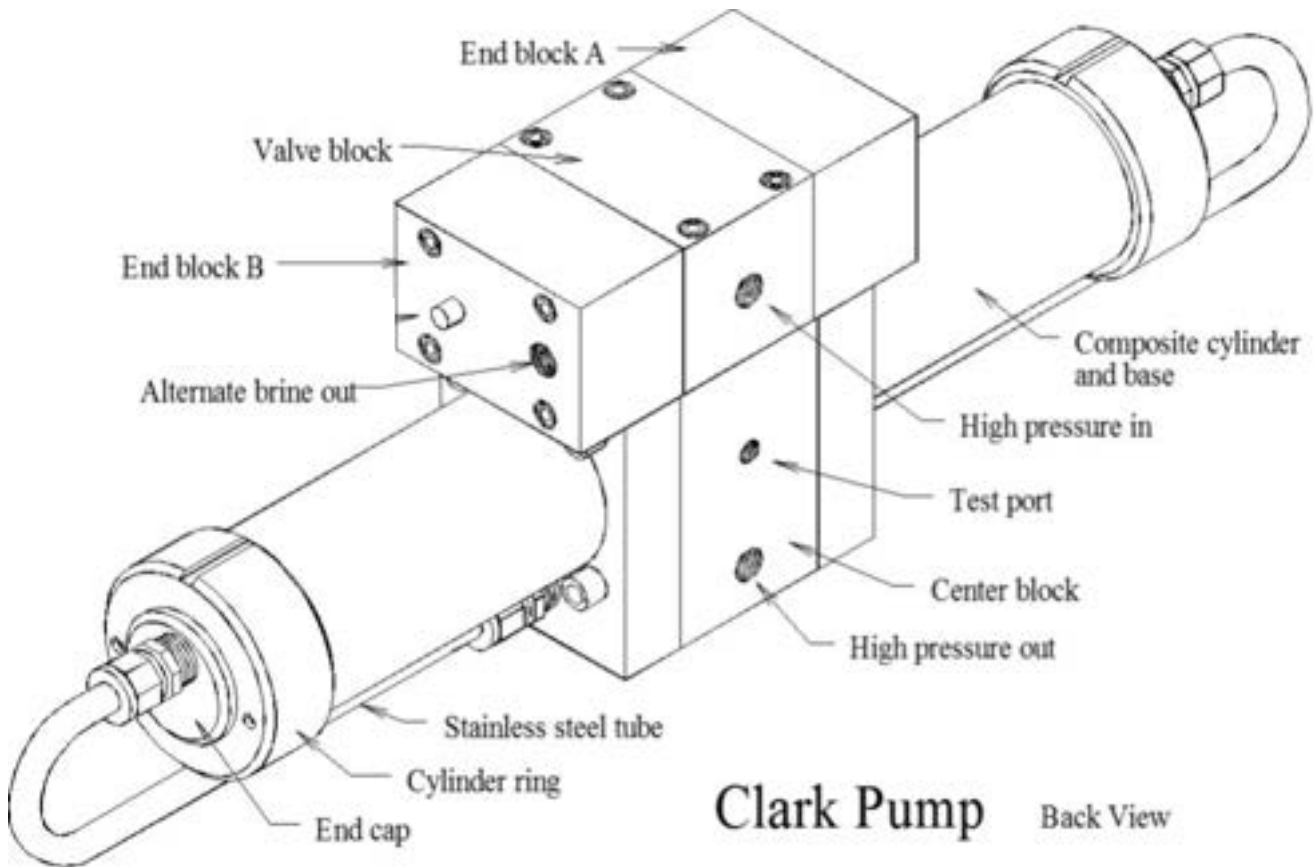

**Clark Pump** Back View



Spool Assembly  
Exploded View

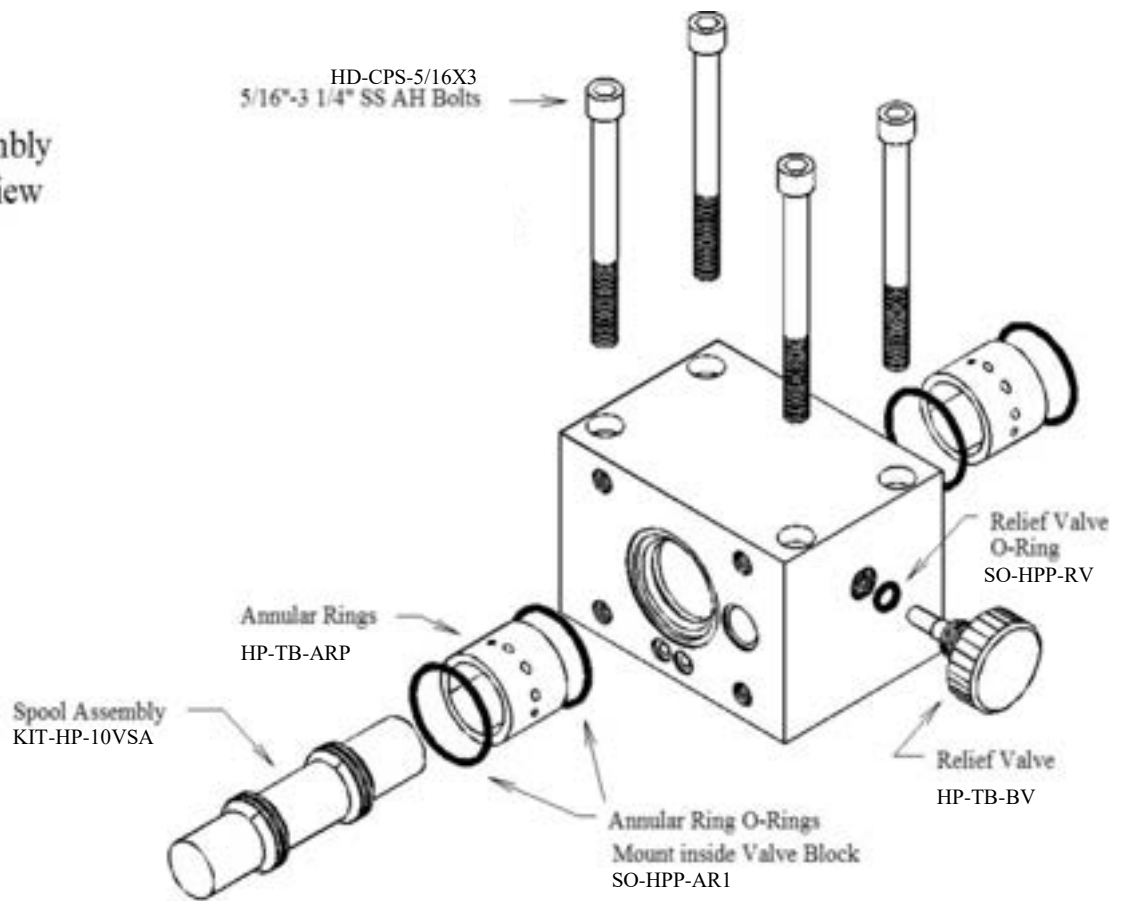

Valve Block

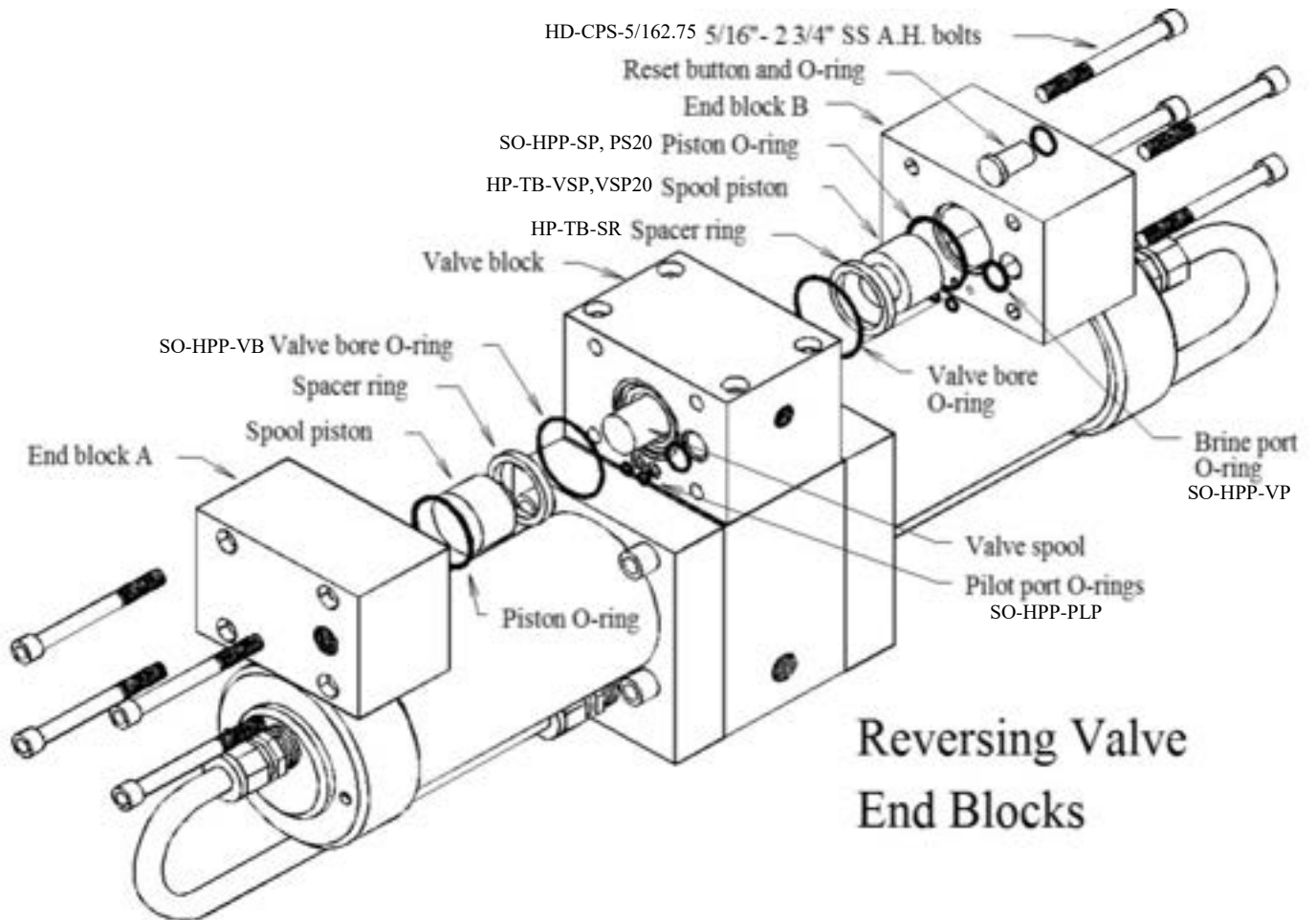

Reversing Valve  
End Blocks

## Parts

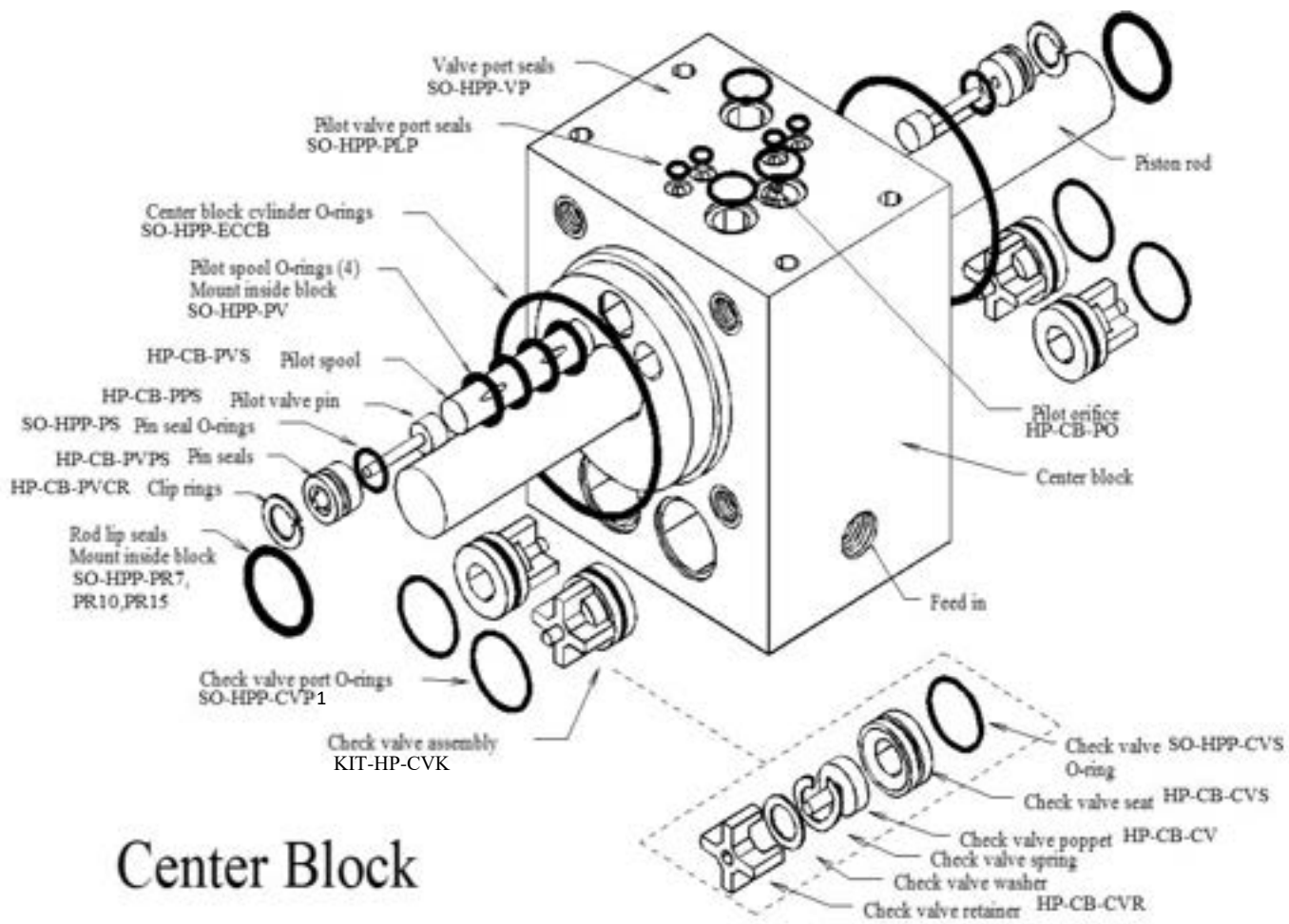

## Center Block

# Parts

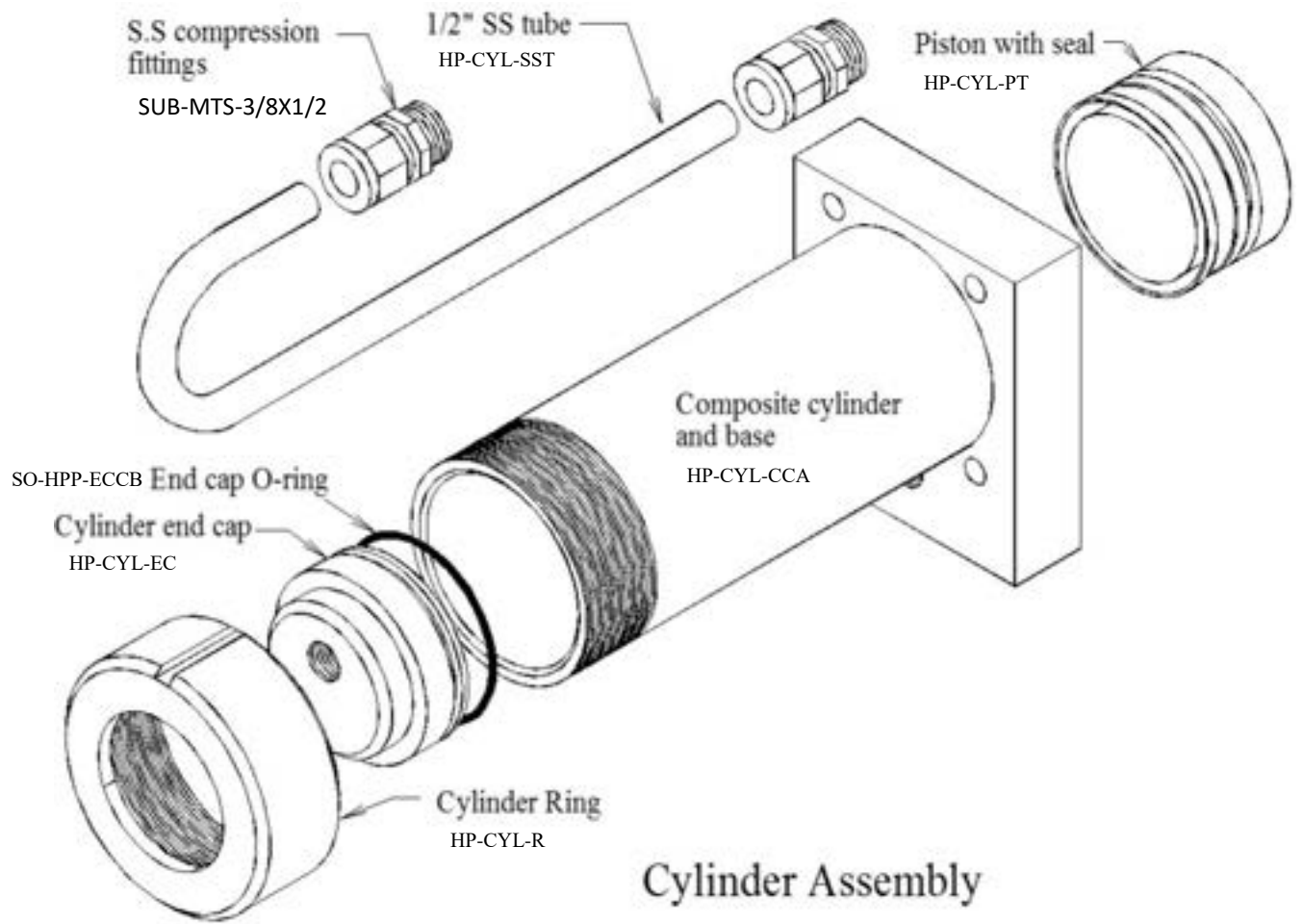





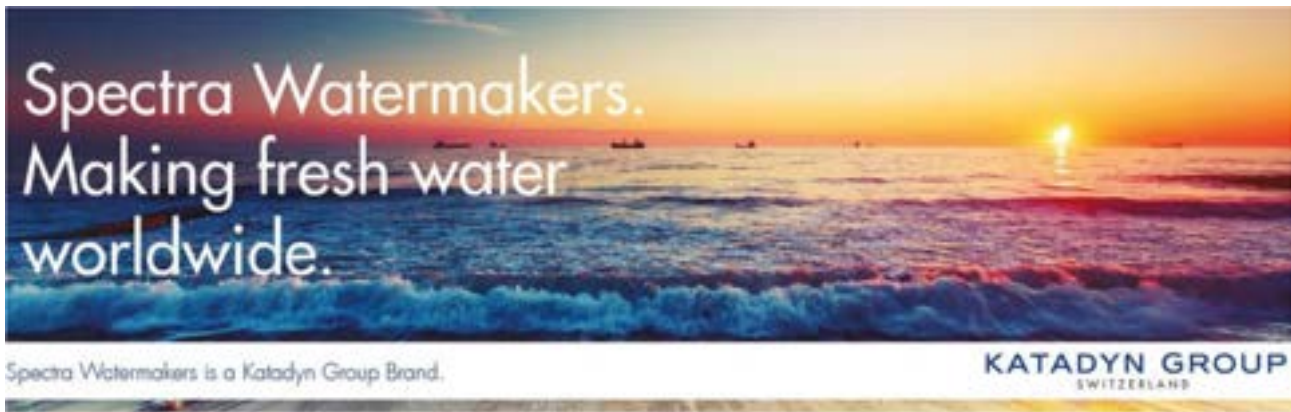

**SPECTRA WATERMAKERS LIMITED LIFETIME WARRANTY**

THIS LIMITED WARRANTY APPLIES TO THE ORIGINAL OWNER OF THE WATERMAKER AND IS NOT TRANSFERRABLE

For warranty information regarding products sold within the European Union please contact [eu-  
rope@spectrawatermakers.com](mailto:eu-<br/>rope@spectrawatermakers.com).

This limited product warranty is provided by Katadyn Desalination LLC, a Business Unit of the Katadyn Group. (“Manufacturer” of “We” or “Our”) to the original, consumer owner of the product (“You” or “Your”) with which this limited product warranty is provided (the “Product.”)

The Manufacturer warrants to You that the product will be free from defects in material and workmanship under normal use and regular service and maintenance, subject to the exclusions described below, for a period of 1 year (the “Warranty Period”) after date of installation, or 15 months after the shipment date, whichever comes first. This warranty will be extended for an additional 12-month period when the product is installed and commissioned by a Katadyn Desalination Authorized Installer. A Spectra Watermakers Commissioning Report must also be returned and approved by the factory. The Spectra Clark Pump has a Limited Lifetime Warranty on Marine systems to the original consumer owner of the product, not inclusive of repair or replacement parts due to wear over time. If the Spectra Clark Pump is used in a Landbased application, the product warranty is provided for a period of 1 year (the “Warranty Period”) after date of purchase (if purchaser is installing system) or date of commissioning (if Spectra dealer is installing system).

You will be required to show written documentation supporting the date of purchase or date of commissioning. If you are unable to provide documentation supporting the date of purchase or commissioning, the warranty period shall be based on the product’s date code and will be determined by the Manufacturer’s sole and absolute discretion.

**WHAT IS COVERED**

Katadyn Desalination LLC. warrants, for the period defined above, that the Product will be free from defects in materials and/or workmanship and will conform to Manufacturers published specifications if installed and maintained in accordance with the Manufacturers Instructions.

**WHAT IS NOT COVERED**

The Warranty does not include service, repair, or replacement to correct damage caused by improper installation, maintenance, improper connection with water systems, external electrical fault, accident, alteration, misuse, abuse, neglect, negligence, (other than Manufacturer’s), acts of God, failure to install or maintain the product in accordance with the Manufacturers instructions.

**DAMAGED OR MISSING PRODUCT**

You must examine the Product upon receipt and notify Katadyn Desalination LLC. if any item is damaged or missing within 30 days from the date of the delivery. Damage due to freight must be reported to Katadyn Desalination LLC. and to the freight carrier within 24 hours of delivery.

## SOLE WARRANTY

THE WARRANTIES SET FORTH IN THIS SECTION ARE THE SOLE AND EXCLUSIVE WARRANTIES GIVEN BY THE MANUFACTURER WITH RESPECT TO THE PRODUCTS AND ARE IN LIEU OF AND EXCLUDE ALL OTHER WARRANTIES, EXPRESS OR IMPLIED, ARISING BY OPERATION OF LAW OR OTHERWISE, INCLUDING WITHOUT LIMITATION, MERCHANTABILITY AND FITNESS FOR A PARTICULAR PURPOSE WHETHER OR NOT THE PURPOSE OR USE HAS BEEN DISCLOSED TO MANUFACTURER IN SPECIFICATIONS, DRAWINGS OR OTHERWISE, AND WHETHER OR NOT MANUFACTURER'S PRODUCTS ARE SPECIFICALLY DESIGNED AND/OR MANUFACTURED BY MANUFACTURER FOR YOUR USE OR PURPOSE.

## WHAT WE WILL DO TO CORRECT PROBLEMS

If You return the defective product during the warranty period and in accordance with the instructions contained herein, shipping prepaid, the Manufacturer shall, at its option and as Your exclusive remedy, repair, correct or replace the product at no charge if the product is found by the Manufacturer to be a valid warranty claim, in Manufacturer's sole discretion. Replacement product may be refurbished and/or different models but will be functionally equivalent to the product or hardware being replaced. Product repaired or replaced during the warranty period shall be covered by the foregoing warranty for the remainder of the original warranty period or ninety (90) days from the date of shipment or purchase, whichever is longer. Contact your Dealer or the Manufacturer's Customer Service at 415-526-2780 to obtain a returns materials authorization (RMA #).

## HOW TO MAKE A WARRANTY CLAIM

If You discover any warranty related issues after 30 days, or You have questions concerning Your product or how to determine when service is needed, please contact your local dealer or contact the Manufacturer's Technical Support at 415-526-2780 or email the Manufacturer at [techsupport@spectrawatermakers.com](mailto:techsupport@spectrawatermakers.com). The following information must be provided as part of Your warranty claim: your name, address, phone number, Your products' model number, Your product's 4-digit serial number, and if necessary, upon request, written confirmation of the date shown on Your purchase receipt and the purchase price paid for the product. All products being returned to the Manufacturer must have a return material authorization (RMA) number to be processed. Any item returned to the Manufacturer without an RMA number will not be accepted by the Manufacturer. Contact your Dealer or Customer Service to obtain an RMA number. Once we have received Your returned product, we will determine, in our sole and absolute discretion, whether Your claim is covered by, or excluded from, this limited warranty. Repairs or modifications made to the product by other than the Manufacturer will nullify this limited warranty. Coverage under this limited warranty is conditioned at all times upon the original purchaser's compliance with these required notification and repair procedures.

LIMITATION OF LIABILITY TO THE FULLEST EXTENT PERMITTED BY LAW, IN NO EVENT, SHALL MANUFACTURER OR ITS AUTHORIZED SERVICE REPRESENTATIVES BE LIABLE FOR ANY INCIDENTAL, SPECIAL, INDIRECT, OR CONSEQUENTIAL DAMAGES, INCLUDING ANY ECONOMIC LOSS, WHETHER RESULTING FROM NONPERFORMANCE, USE, MISUSE OR INABILITY TO USE THE PRODUCT OR THE MANUFACTURER'S OR ITS AUTHORIZED SERVICE REPRESENTATIVE'S NEGLIGENCE. THE MANUFACTURER SHALL NOT BE LIABLE FOR DAMAGES CAUSED BY DELAY IN PERFORMANCE AND, IN NO EVENT, REGARDLESS OF THE FORM OF THE CLAIM OR CAUSE OF ACTION (WHETHER BASED IN CONTRACT, INFRINGEMENT, NEGLIGENCE, STRICT LIABILITY, OTHER TORT OR OTHERWISE), SHALL MANUFACTURER'S LIABILITY TO YOU EXCEED THE PRICE PAID BY THE ORIGINAL OWNER FOR THE MANUFACTURER'S PRODUCT.

The term "consequential" damages shall include, but not be limited to, loss of anticipated profits, business interruption, loss of use or revenue, the cost of capital or loss or damage to property or equipment. Some states do not allow the exclusion or limitation of incidental or consequential damages, so the above limitation may not apply to you. This limited warranty gives you specific legal rights, and you may also have may other rights which vary from State to State.

--- CUT HERE ---

## Spectra Product Registration Form

**Any commissioning/install report (and additional 12 month warranty) may be rejected at the sole discretion of Spectra Watermakers if the system is not installed correctly.**

### Registration (To be completed by owner)

**System Details:**

Model \_\_\_\_\_ Date of install: \_\_\_\_\_  
 4-digit S/N \_\_\_\_\_ Clark Pump S/N: \_\_\_\_\_ Voltage \_\_\_\_\_  
 Dealer/distributor: \_\_\_\_\_ Boat Location: \_\_\_\_\_ max speed: \_\_\_\_\_

Boat model or type (i.e. Leopard 44, Beneteau 55' powerboat, catamaran, powercat, 42' sailboat...)

What type of boating will you be doing and what will the watermaker primarily be used for:

**Original Owner Details:**

Name: \_\_\_\_\_ Phone Number: \_\_\_\_\_  
 Email Address: \_\_\_\_\_  
 Address (Optional): \_\_\_\_\_  
 \_\_\_\_\_  
 \_\_\_\_\_

**Submission for Approval:**

Please submit this document along with the Installation and Commissioning Reports to Spectra Watermakers for approval. Submissions can be scanned and emailed or mailed directly to the factory. Spectra Watermakers Technical Support will email the original owner and the authorized distributor with the status of submission.

Email: [TechSupport@SpectraWatermakers.com](mailto:TechSupport@SpectraWatermakers.com)

Phone: +1(415) 526-2780

Address: Katadyn Desalination  
 Technical Department  
 2220 S. McDowell Blvd Ext  
 Petaluma, CA 94954  
 USA

**Please keep a copy of these reports for your records.**



--- CUT HERE ---

## Spectra Watermakers Installation Report

(To be completed by authorized installer)

The following checklist is designed to confirm that the watermaker installation meets Spectra standards. Fill out the checklist as completely as possible. Check any boxes that apply and note any concerns. Please document any discrepancies or concerns with photos.

### INLET

- Inlet Seacock is below waterline
- Inlet Seacock is dedicated
- Inlet Seacock is shared
- Inlet Thru-Hull forward facing scoop
- Has strainer
- Has diving snorkel
- Sea chest
- Other

Thru Hull Size: \_\_\_\_\_ IN/CM

Approximate location on vessel and notes: \_\_\_\_\_

### FEED PUMP MODULE

- Feed pump module is mounted upright
- Clearance for filter cartridge changes
- Intake hoses are free of kinks
- Pressurized domestic water is connected to carbon filter

Distance from waterline: \_\_\_\_\_ FT/M above /below  the waterline

### HIGH PRESSURE MODULE and BRINE DISCHARGE

- Pressure relief valve is accessible
- Brine discharge has no obstructions and vents to atmosphere

Notes: \_\_\_\_\_

### PRODUCT WATER TUBING

- Product water flows into top of freshwater tank
- Freshwater tank is vented

Notes: \_\_\_\_\_

### INSTALLATION SIGN OFF

Technician's Name: \_\_\_\_\_ Date: \_\_\_\_\_

Technician's Signature: \_\_\_\_\_

Distributor/Dealer \_\_\_\_\_



--- CUT HERE ---

# Spectra Watermakers Commissioning Report – Page 1

(To be completed by authorized installer)

The following checklist is designed to confirm that the watermaker installation meets Spectra standards and that the system is performing at specification.

Fill out the below checks as completely as possible. Check any boxes that apply and note any concerns.

## PURGE

- Storage Chemicals have been purged with PRV open

Length of purge: \_\_\_\_\_ MIN/HOUR

## RUN HIGH MODE CHECKS

Product Flow: \_\_\_\_\_ GPH/LPH

Product Quality: \_\_\_\_\_ PPM

Feed Pressure: \_\_\_\_\_ PSI/BAR

Brine Flow Rate (With Pressure Relief Valve Closed): \_\_\_\_\_ GPM/LPM

Measurement taken with:

Technician Flow meter. Brand \_\_\_\_\_

Hand Measurement: \_\_\_\_\_ Gal/Liters in \_\_\_\_\_ SEC/MIN

Notes: \_\_\_\_\_  
\_\_\_\_\_

## FRESHWATER FLUSH

- Ships pressurized water is connected

What is the ppm of brine discharge at the end of the flush \_\_\_\_\_

Flush duration is \_\_\_\_\_ Minutes

Notes: \_\_\_\_\_  
\_\_\_\_\_

\*If the system does not have a dedicated forward-facing scoop type thru-hull or will be on a vessel that moves faster than 15 knots the system needs to complete the following sea trial checks.

Spectra Watermakers reserves the right to require a sea trial from any customer before approving a commissioning report.

## SEA TRIAL

- Watermaker will flush while underway
- Watermaker will start while underway

While the vessel is underway moving \_\_\_\_\_ KNOTS/MPH/KPH the watermaker is producing \_\_\_\_\_ GPH/LPH at \_\_\_\_\_ PPM



# Spectra Watermakers Commissioning Report – Page 2

## OWNER EDUCATION

Owner has been trained on the following:

Know locations of

- Seacock/Thru-hull
- Sea strainer Module
- and Feed Pump Module
- Prefilters
- High Pressure Module
- Clark Pump Pressure Relief Valve
- Product water inlet to Freshwater Tank
- Sampling Tap
- Brine Discharge location
- Service hoses and storage chemicals
- User Manual
  
- How to power the watermaker off and on at the main breaker.
- How to run the watermaker.
- How to freshwater flush and the importance of freshwater flushing.
- Knows when the ships domestic freshwater pump is on.
- Knows which prefilter cartridges to use and how to change them.
- Knows how to service the sea strainer module.
- Knows where the carbon block filter is and is familiar with (6 months) service frequency.
- Have visually seen the overboard brine discharge (Should know when the system is pumping water).
- Knows how to sample the product water.
- Understand when the Clark Pump is under pressure and cycling.
- Have seen how the service hoses and bucket are used to circulate seawater or freshwater through the system.

Notes: \_\_\_\_\_

\_\_\_\_\_

\_\_\_\_\_

\_\_\_\_\_

\_\_\_\_\_

\_\_\_\_\_

<b>COMMISSIONING REPORT SIGN OFF</b>	
Technician's Name:	_____
Technician's Signature:	_____
Owner's Name	_____
Owner's Signature	_____

